

AHE

ALLIANCE HOSE DE MÉXICO

CATÁLOGO DE PRODUCTOS



**MANGUERAS
DE TEFLÓN**



**MANGUERAS
DE SILICÓN**



**CONEXIONES
DE LATÓN**



AHE
ALLIANCE HOSE & EXTRUSIONS, INC.
MADE IN U.S.A.

Tecnología que
proporciona un
mejor

**aislamiento a
la vibración** y
mayor absorción
al golpeo para
evitar rupturas
internas en la
manguera.

¿POR QUÉ AHE?



Contamos con una línea de producción completa para asegurar el control total de todo el proceso de manufactura. Tenemos un amplio inventario de materia prima que utilizamos para elaborar y mezclar nuestros propios materiales de silicón que garantizan resistencia a ambientes extremos, ozono, resistencia a fluidos, etc. Probamos estos materiales en nuestro laboratorio de gomas de alta tecnología, en nuestras instalaciones.

Una vez aprobados, los materiales son procesados y transformados en mangueras con maquinaria altamente especializada, la cual diseñamos y construimos nosotros mismos. Una vez finalizado el proceso, nuestras mangueras son inspeccionadas visualmente y probadas, de acuerdo a requerimientos tales como adhesión y resistencia a la ruptura. Los resultados son mangueras que superan a la competencia en cada ocasión.

TENEMOS UN AMPLIO INVENTARIO DE MATERIA PRIMA PARA ELABORAR Y MEZCLAR NUESTROS PROPIOS MATERIALES DE SILICÓN.

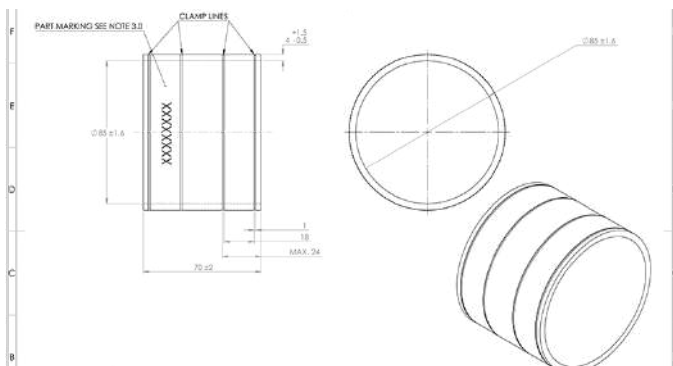

Todas nuestras mangueras son hechas a mano en nuestra fábrica en los EE. UU. Nuestro equipo técnico altamente capacitado se siente orgulloso de su trabajo y está dedicado a brindar un servicio con un nivel de calidad que no ha sido superado por ninguna otra compañía de mangueras.

Estamos certificados por el Sistema de Gestión de Calidad **ISO 9001:2015**, nuestro departamento de Q&A realiza un monitoreo y análisis de nuestro desempeño, lo que nos hace estar comprometidos con los preceptos de Mejora Continua.

TODAS LAS MANGUERAS SON HECHAS A MANO EN NUESTRA FÁBRICA DE EE. UU.

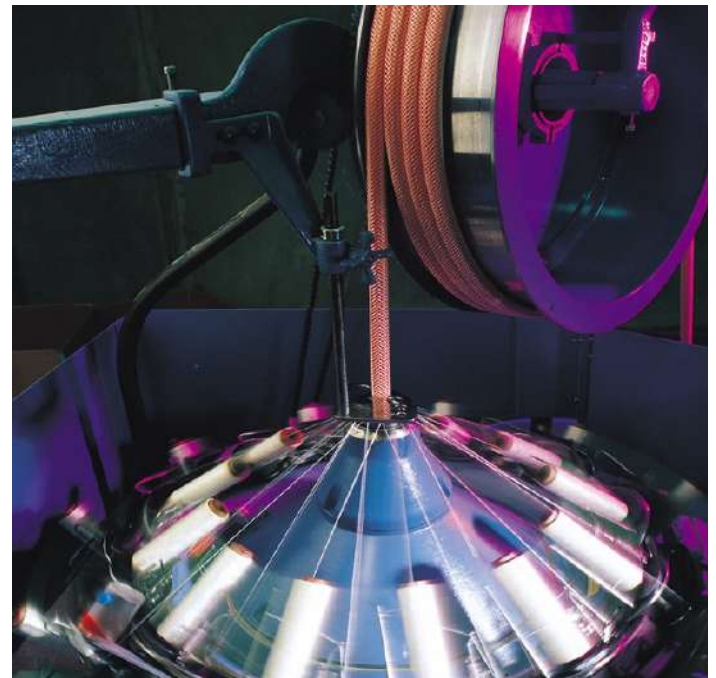



EXPERIENCIA

Alliance Hose & Extrusions Inc., nace en 1999 como una subsidiaria de California Gasket & Rubber Corp. (CGR), quienes desde 1942 fabrica sellos, juntas, empaques y otros productos de elastómeros para maquinaria industrial.

Cubrimos la demanda del mercado, siendo un proveedor de suministro para fabricantes de equipo original (OEM), con una fuente confiable de productos de silicón con calidad de alto desempeño, en tiempo oportuno y a un precio competitivo.

Nos respaldan más de 70 años de experiencia en productos industriales y aeronáutica, así como el desarrollo de productos para el Departamento de Defensa de EE. UU; hemos crecido rápidamente para convertirnos en la fuente primaria de compañías alrededor del mundo.

Además de ser fabricante de equipo original, nuestra base de clientes se ha expandido para incluir accesorios para tuning de automóviles y motocicletas, reconstructores de motores, equipos de carreras automovilísticas y comercio de internet.



CALIFORNIA
GASKET &
RUBBER CORP.

+ MÁS DE 70 AÑOS

SUMINISTRANDO PRODUCTOS DE CALIDAD

MANGUERAS DE SILICÓN

De Alto Desempeño



Post enfriador de aire (CAC)

Mangueras de silicón para cargas de aire frío y caliente



Manguera de silicón resistente para turbocargador con refuerzos de aramida para el trabajo pesado a altas temperaturas.

Sus ondulaciones son ideales para resistir la tensión y rigidez de las vibraciones a altas temperaturas.

Presentan gran resistencia al ozono, agentes oxidantes y al envejecimiento térmico.

Notas:
No se recomienda su uso para el transporte de partículas abrasivas.
Línea de fluorosilicón disponible para mejor resistencia a salpicaduras.

Construcción

Silicón A-E con trenzado de aramida. Contiene anillos de acero inoxidable según modelo.

Refuerzos

3 o 4 capas (estándar).

Temperatura

(-55°C a 260°C)
(-67°F a 500°F)

Certificación

Especificaciones de la Norma SAE J20R1 Clase A.

Medidas

Gran variedad de tamaños, longitudes y número de anillos.

Colores

Naranja (estándar), azul, negro y rojo.



No. De parte AHE	Diámetro interno	Anillos	Longitud	Capas	Presión de trabajo PSI min	Presión de ruptura PSI min
C2M4661/75-136RM	61mm/75mm	2	136mm	4	63	250
C2M4664/89X3-146RM	64mm/89mm	2	146mm	4	50	200
C2M4689-140RM	89mm	2	133mm	4	50	200
C3M3662-160R	62mm	3	160mm	3	37	149
C3M46102-152R	102mm	3	152mm	4	37	149
C3M46102-203R	102mm	3	203mm	4	37	149
C4M3670-170R	70mm	4	170mm	3	31	125
C5M3670-195R	70mm	5	195mm	3	31	125
C5M3680/100-225RB	80mm/100mm	5	225mm	3	12	49
C5M3680/84-215R	80mm/84mm	5	215mm	3	12	49
C5M4670-203RM	70mm	5	203mm	4	63	250
C5M4664-216BLM	64mm	5	216mm	4	63	250
C6M46102-228R	102mm	6	228mm	4	37	149
C6M46102-254R	102mm	6	254mm	4	37	149
C6M4689-215R	89mm	6	215mm	4	50	200
C8M3689-305R	89mm	8	305mm	3	19	49
C17M46102-483RM	102mm	17	483mm	4	37	149
C246400-6R	4"	2	6"	4	37	149
C346200-6R	2"	3	6"	4	88	350
C346250-6RM	2 1/2"	3	6"	4	63	250
C346300-6R	3"	3	6"	4	50	200
C346300-6RM	3"	3	6"	4	50	200
C346350-6R	3 1/2"	3	6"	4	50	200
C346400-6RM	4"	3	6"	4	37	149
C346400-7R	4"	3	7"	4	37	149
C346400-8RM	4"	3	8"	4	37	149
C346450-6RM	4 1/2"	3	6"	4	37	149
C746400-12.5R	4"	7	12 1/2"	4	37	149

Mangueras para aplicaciones Mercedes Benz



No. de Parte AHE	Equivalente M. Benz	Modelo	Motor	Diámetro	Longitud	Anillos	Capas	Color	Flurosilicón	Refuerzos
CODO 90°										
AHP9043236256-4BK	A 001 501 08 82	EvoBus	906 EPA04	60MM/65MM	102MM	Sin Anillos	4	Negra		Poliéster
COPLES										
M4689-70R	A 376 094 03 82	XBC	924 EPA04	89 MM	70 MM	Sin Anillos	4	Naranja		Aramida
M4685-70R	A 376 094 70 82	XBC	906 EPA04	85 MM	70MM	Sin Anillos	4	Naranja		Aramida
M4680-70R-FL	A 382 528 79 82	XBC	906 EPA04	80 MM	70MM	Sin Anillos	4	Naranja	Línea de Flurosilicón	Aramida
M46100-70R-FL	A 382 528 80 82	XBC	906	100 MM	70 MM	Sin Anillos	4	Naranja	Línea de Flurosilicón	Aramida
M4665-70R	A 476 094 70 82	XBC	906 EPA04	65 MM	65 MM	Sin Anillos	4	Naranja		Aramida
M46100-80R-FL	A 664 528 76 82	XBC	924 EPA04	100 MM	80MM	Sin Anillos	4	Naranja	Línea de Flurosilicón	Aramida
M4670-70R-FL	A 668 528 10 82	XBC	906	70 MM	70 MM	Sin Anillos	4	Naranja	Línea de Flurosilicón	Aramida
M36101.6-73R	A 685 528 96 82	OMC	924 EURO3	101.6 X 73MM	73 MM	Sin Anillos	3	Naranja		Aramida
M3685-65R	A 904 094 11 82	MBO	924 EPA04	85 MM	65 MM	Sin Anillos	3	Naranja		Aramida
M3685-82R	A 906 094 03 82	OMC	906	85 MM	82 MM	Sin Anillos	3	Naranja		Aramida
M3685-90R	A 906 094 09 82	OMC	906	85 MM	90 MM	Sin Anillos	3	Naranja		Aramida
TURBO CAC										
C3M3676/89-140B	A 904 094 05 82	MBO	924 EURO3	76/89 MM	140 MM	3	3	Negra		Aramida
C3M3676/80-140B	A 904 094 06 82	MBO	924 EPA04	76/80 MM	140 MM	3	3	Negra		Aramida
C3M3676/80-140R	A 904 094 07 82	MBO	924 EPA04	76/80 MM	140 MM	3	3	Naranja		Aramida
C3M3676-140R	A 904 094 08 82	MBO	924 EPA04	76 MM	140 MM	3	3	Naranja		Aramida
C3M3676-140B	A 904 094 09 82	MBO	924 EPA04	76 MM	140 MM	3	3	Negra		Aramida
C3M3680/85-145B	A 906 094 05 82	OMC	906	80/85 MM	145 MM	3	3	Negra		Aramida
C4M4680-155R	A 368 500 01 75	XBC	924 EPA04	80 MM	155 MM	4	4	Naranja		Aramida
C5M4699-197R-FL	A 001 501 91 82	EvoBus	906 EPA04	99 MM	196MM	5	4	Naranja	Línea de Flurosilicón	Aramida
C5M3380/85-215B	A 696 500 70 75	XBC	906 EPA04	80/85MM	215 MM	5	3	Negra		Poliéster
C5M3380/85-253B-FL	A 384 501 14 82	XBC	924 EPA04	80/85 MM	253MM	5	3	Negra	Línea de Flurosilicón	Poliéster
C5M3680/85-215R	A 696 500 72 75	XBC	907 EPA04	80/85 MM	215 MM	5	3	Naranja		Aramida
C5M3680/85-215B	A 906 094 06 82	OMC	924 EURO3	80/85 MM	215 MM	5	3	Negra		Aramida
C5M4680/100-225RM	A 000 501 91 82	OMC	906	80/100	225MM	5	4	Naranja		Aramida
C6M4680/85-215R	A 382 500 01 75	XBC	906 EPA04	80/85 MM	215 MM	6	4	Naranja		Aramida
C7M4680/85-253R	A 384 500 07 75	MBC-O	924	80/85 MM	253 MM	7	4	Naranja		Aramida

Mangueras Rectas



Mangueras de silicón para refrigerante

Manguera recta de Silicón con refuerzos de poliéster para el trabajo pesado resistente a altas temperaturas.

Recomendada para conducción de aire o agua a presión y elevada temperatura, puede utilizarse en vehículos del sector industrial, autobuses y camiones, sistemas de refrigeración, calefacción, de cogeneración y motores marinos. Se utiliza en tramos rectos sin curvas.

Presenta gran resistencia al ozono, agentes oxidantes y al envejecimiento térmico.

Notas:
No se recomienda su uso para el transporte de partículas abrasivas.
Disponible también en fibra de vidrio.

Construcción

Silicón A/E con refuerzo de poliéster.

Refuerzos

3 capas (estándar).

Temperatura

(-55°C a 176°C)
(-67°F a 350°F)

Certificación

Cumple y excede las especificaciones de la Norma SAE J20R1 Clase A.

Longitud

36" pulgadas, medida estándar.

Colores

Azul (estándar), naranja, negro y rojo.



No. De parte AHE	Diámetro Interno	Longitud	Capas	Presión de trabajo PSI min	Presión de ruptura PSI min
AHP33050-36BL	1/2"	36"	3	106	425
AHP33062-36BL	5/8"	36"	3	94	376
AHP33075-36BL	3/4"	36"	3	81	325
AHP33087-36BL	7/8"	36"	3	81	325
AHP33100-36BL	1"	36"	3	75	299
AHP33113-36BL	1 1/8"	36"	3	75	299
AHP33125-36BL	1 1/4"	36"	3	69	276
AHP33138-36BL	1 3/8"	36"	3	69	276
AHP33150-36BL	1 1/2"	36"	3	63	250
AHP33163-36BL	1 5/8"	36"	3	63	250
AHP33175-36BL	1 3/4"	36"	3	56	225
AHP33200-36BL	2"	36"	3	50	200
AHP33225-36BL	2 1/4"	36"	3	44	176
AHP33238-36BL	2 3/8"	36"	3	44	176
AHP33250-36BL	2 1/2"	36"	3	37	149
AHP33262-36BL	2 5/8"	36"	3	31	125
AHP33275-36BL	2 3/4"	36"	3	31	125
AHP33300-36BL	3"	36"	3	22	87
AHP33312-36BL	3 1/8"	36"	3	22	87
AHP33325-36BL	3 1/4"	36"	3	22	87
AHP33338-36BL	3 3/8"	36"	3	19	75
AHP33350-36BL	3 1/2"	36"	3	19	49
AHP33375-36BL	3 3/4"	36"	3	12	49
AHP33400-36BL	4"	36"	3	12	49
AHP33450-36BL	4 1/2"	36"	3	12	49

Mangueras para Turbocompresor

Mangueras de silicón para refrigerante



Manguera recta de Silicón con refuerzos de aramida para el trabajo pesado resistente a altas temperaturas.

Recomendada para conducción de aire o agua a presión y elevada temperatura, puede utilizarse en vehículos del sector industrial, autobuses y camiones.

Presenta gran resistencia al ozono, agentes oxidantes y al envejecimiento térmico.

Notas:
No se recomienda su uso para el transporte de partículas abrasivas.

Construcción

Silicón A/E con refuerzo de aramida.

Refuerzos

3 o 4 capas (estándar).

Temperatura

(-55°C a 260°C)
(-67°F a 500°F)

Certificación

Especificación SAE J20R1 Clase A.

Longitud

36" pulgadas, medida estándar.

Colores

Naranja (estándar), azul, negro y rojo.



No. De parte AHE	Diámetro Interior	Longitud	Capas	Presión de trabajo PSI min	Presión de ruptura PSI min
C036100-36	1"	36"	3	75	299
C036150-36	1 1/2"	36"	3	63	250
C036175-36	1 3/4"	36"	3	56	225
C036200-36	2"	36"	3	50	200
C036225-36	2 1/4"	36"	3	44	176
C036238-36	2 3/8"	36"	3	44	176
C036250-36	2 1/2"	36"	3	37	149
C036263-36	2 5/8"	36"	3	31	125
C036275-36	2 3/4"	36"	3	31	125
C036300-36	3"	36"	3	22	87
C036338-36	3 3/8"	36"	3	19	75
C036350-36	3 1/2"	36"	3	19	49
C036375-36	3 3/4"	36"	3	12	49
C036400-36	4"	36"	3	12	49
C036450-36	4 1/2"	36"	3	12	49
C046400-36	4"	36"	4	37	149

Codos 45° y 90°

Mangueras de silicón tipo codo.



Codos de Silicón con refuerzos de poliéster o aramida para el trabajo pesado y resistente a altas temperaturas.

Recomendados para conducción de aire o agua a presión y elevada temperatura, puede utilizarse en vehículos del sector industrial, autobuses y camiones, sistemas de refrigeración y/o calefacción, se utiliza para las conexiones con espacio limitados.

Presenta gran resistencia al ozono, agentes oxidantes y al envejecimiento térmico.

Notas:
No se recomienda su uso para el transporte de partículas abrasivas.
Disponible también en fibra de vidrio.

Construcción

Silicón AHE con refuerzo de poliéster o aramida.

Refuerzos

3 o 4 capas (estándar).

Temperatura

Refuerzo Poliéster
(-55°C a 176°C) (-67°F a 350°F)

Refuerzo Aramida
(-55°C a 260°C) (-67°F a 500°F)

Certificación

Cumple y excede las especificaciones de la Norma SAE J20R1 Clase A.

Medidas

3" y 6" pulgadas de longitud, Ángulos de 45° y 90° (Medidas estándar).

Colores

Azul (estándar), naranja, negro y rojo

CODOS 45°

No. De Parte AHE	DI	LA	LB	LE	Capas	Grados	Espesor	Presión de trabajo PSI min	Presión de ruptura PSI min
3 REFUREZOS "CORTO"									
AHP4533200-3BL	2"	3"	3"	9.5"	3	45	0.200	19	49
AHP4533400-3BL	4"	3"	3"	9.5"	3	45	0.170	56	225
4 REFUREZOS "CORTO"									
AHP4543175-3BL	1 3/4"	3"	3"	9.5"	4	45	0.200	31	125
AHP4543250-3BL	2 1/2"	3"	3"	9.5"	4	45	0.200	19	49
AHP4543300-3BL	3"	3"	3"	9.5"	4	45	0.200	88	350
AHP4543350-3BL	3 1/2"	3"	3"	9.5"	4	45	0.200	75	299
AHP4543400-3BL	4"	3"	3"	9.5"	4	45	0.200	63	250
AHP4546400-3BL ARAMIDA	4"	3"	3"	9.5"	4	45	0.200	63	250
AHP4546275-3BL ARAMIDA	2 3/4"	3"	3"	9.5"	4	45	0.200	50	200
AHP4546300-3BL ARAMIDA	3"	3"	3"	9.5"	4	45	0.200	50	200
5 REFUERZOS CORTO									
AHP4556275-3BL ARAMIDA	2 3/4"	3"	3"	9.5"	5	45	0.200	37	149
AHP4553400-3BL	4"	3"	3"	9.5"	5	45	0.200	63	250
AHP4556400-3BL ARAMIDA	4"	3"	3"	9.5"	5	45	0.230	37	149
4 REFUERZOS "LARGO"									
AHP4546275-6BL ARAMIDA	2 3/4"	6"	6"	16"	4	45	0.230	88	350
AHP4543300-6BL	3"	6"	6"	16"	4	45	0.230	75	299
AHP4543350-6BL	3 1/2"	6"	5"	16"	4	45	0.230	63	250
AHP4543400-6BL	4"	6"	6"	16"	4	45	0.230	50	200
AHP4543250-6BL	2.5"	6"	6"	16"	4	45	0.209	37	149
AHP4546400-6BL ARAMIDA	4"	6"	6"	16"	4	45	0.230	19	49
5 REFUERZOS "LARGO"									
AHP4556250-6BL ARAMIDA	2 1/2"	5"	6"	16"	5	45	0.230	63	250
AHP4553400-6BL	4"	6"	6"	16"	5	45	0.230	50	200

CODOS 90°

No. De Parte AHE	DI	LA	LB	LE	Capas	Grados	Espesor	Presión de trabajo PSI min	Presión de ruptura PSI min
3 REFUERZOS "CORTO"									
AHP9033350-3BL	3 1/2"	3"	3"	9.5"	3	90	0.200	19	49
3 REFUERZOS "LARGO"									
AHP9033175-6BL	1 3/4"	6"	6"	13.5"	3	90	0.170	56	225
AHP9033275-6BL	2 3/4"	6"	6"	13.5"	3	90	0.170	31	125
AHP9033350-6BL	3 1/2"	6"	6"	13.5"	3	90	0.170	19	49
4 REFUERZOS "LARGO"									
AHP9043200-6BL	2"	6"	6"	13.5"	4	90	0.200	88	350
AHP9043225-6BL	2 1/4"	6"	6"	13.5"	4	90	0.200	75	299
AHP9043250-6BL	2 1/2"	6"	6"	13.5"	4	90	0.200	63	250
AHP9043275-6BL	2 3/4"	6"	6"	13.5"	4	90	0.200	63	250
AHP9043300-6BL	3"	6"	6"	13.5"	4	90	0.200	50	200
AHP9043350-6BL	3 1/2"	6"	6"	13.5"	4	90	0.200	50	200
AHP9043400-6BL	4"	6"	6"	13.5"	4	90	0.200	37	149
AHP9046400-6BL ARAMIDA	4"	6"	6"	13.5"	4	90	0.230	37	149
5 REFUERZOS "CORTO"									
AHP9056275-3BL ARAMIDA	2 3/4"	3"	3"	9.5"	5	90	0.230	63	250
AHP9053400-3BL	4"	3"	3"	9.5"	5	90	0.230	37	149
5 REFUERZOS "LARGO"									
AHP9053200-6BL	2"	6"	6"	13.5"	5	90	0.230	88	350
AHP9053225-6BL	2 1/4"	6"	6"	13.5"	5	90	0.230	75	299
AHP9053250-6BL	2 1/2"	6"	6"	13.5"	5	90	0.230	63	250
AHP9053300-6BL	3"	6"	6"	13.5"	5	90	0.230	50	200
AHP9053400-6BL	4"	6"	6"	13.5"	5	90	0.230	37	149
AHP9053400-7BL	4"	7"	7"	16.5"	5	90	0.230	37	149
AHP9056250-6BL ARAMIDA	2 1/2"	6"	6"	13.5"	5	90	0.230	63	250
AHP9056300-6BL ARAMIDA	3"	6"	6"	13.5"	5	90	0.230	50	200
TIPO GUSANO									
AHPS43275-10.25BL (TIPO S)	2 3/4"	5.25"	5.25"	10.25"	4	"S"	0.200	63	250

No. De Parte AHE	DI1	DI2	LA	LB	LE	Capas	Grados	Espesor	Presión de trabajo PSI min	Presión de ruptura PSI min
CODOS 90° REDUCTORES										
AHP9043200250-6BL	2"	2 1/2"	6"	6"	13"	4	90	0.20	75	299
AHP9043275300-4BL	2 3/4"	3"	4"	4"	9"	4	90	0.20	50	200

Coples

Mangueras de silicón



Cople de Silicón con refuerzos de poliéster para el trabajo pesado resistente a altas temperaturas.

Recomendada para conducción de aire o agua a presión y elevada temperatura, puede utilizarse en vehículos del sector industrial, autobuses y camiones, sistemas de refrigeración y/o calefacción, de cogeneración y motores marinos. Se utiliza en tramos rectos sin curvas.

Presenta gran resistencia al ozono, agentes oxidantes y al envejecimiento térmico.

Notas:
No se recomienda su uso para el transporte de partículas abrasivas.
Otras medidas de longitud existentes.

Construcción

Silicón AHE con refuerzo de poliéster.

Refuerzos

3 capas (estándar).

Temperatura

Refuerzo Poliéster
(-55°C a 176°C) (-67°F a 350°F)

Refuerzo Aramida
(-55°C a 260°C) (-67°F a 500°F)

Certificación

Cumple y excede las especificaciones de la Norma SAE J20R1 Clase A.

Longitud

3" pulgadas, medida estándar.

Colores

Azul (estándar), negro y rojo.



No. De parte A-E	Diámetro interno	Longitud	Presión de trabajo PSI min	Presión de ruptura PSI min
AHP33200-3BL	2"	3"	50	200
AHP33250-3BL	2 1/2"	3"	37	149
AHP33300-3BL	3"	3"	22	87
AHP33338-3.5BL	3 3/8"	3 1/2"	19	75
AHP33338-6BL	3 3/8"	6"	19	75
AHP33350-3BL	3 1/2"	3"	19	49
AHP33267-3BL	2 5/8"	3"	31	125
AHP33400-3BL	4"	3"	12	49



Reductores

Mangueras con reducción de silicón



Reductores de Silicón con refuerzo de poliéster—para el trabajo pesado resistente a altas temperaturas.

Recomendada para conducción de aire o agua a presión y elevada temperatura, puede utilizarse en vehículos del sector industrial, autobuses y camiones, sistemas de refrigeración y/o calefacción, de cogeneración y motores marinos. Se utiliza en tramos rectos sin curvas.

Presenta gran resistencia al ozono, agentes oxidantes y al envejecimiento térmico.

Notas:
No se recomienda su uso para el transporte de partículas abrasivas.
Otras medidas de longitud existentes.

Construcción

Silicón AHE con refuerzo de poliéster.

Refuerzos

3 o 4 capas (estándar).

Temperatura

Refuerzo Poliéster
(-55°C a 176°C) (-67°F a 350°F)

Refuerzo Aramida
(-55°C a 260°C) (-67°F a 500°F)

Certificación

Cumple y excede las especificaciones de la Norma SAE J20R1 Clase A.

Longitud

3" pulgadas, medida estándar.

Colores

Azul (estándar), negro y rojo.



No. De parte AHE	D I 1	D I 2	Longitud	Capas	Presión de trabajo PSI min	Presión de ruptura PSI min
AHP43150/175-3BL	1 1/2"	1 3/4"	3"	4	100	400
AHP43175/200-3BL	1 3/4"	2"	3"	4	88	350
AHP43200/225-3BL	2"	2 1/4"	3"	4	75	299
AHP43200/300-3BL	2"	3"	3"	4	63	250
AHP43225/250-3BL	2 1/4"	2 1/2"	3"	4	75	299
AHP43300/400-3BL	3"	4"	3"	4	37	149
AHP43225/250-4BL	2 1/4"	2 1/2"	4"	4	75	299



Jorobas

Mangueras tipo joroba de silicón



Manguera tipo joroba de Silicón con refuerzos de poliéster o aramida para el trabajo pesado resistente a altas temperaturas.

Recomendada para conducción de aire o agua a presión y elevada temperatura, puede utilizarse en vehículos del sector industrial, autobuses y camiones, sistemas de refrigeración y/o calefacción, de cogeneración y motores marinos. Se utiliza en tramos rectos sin curvas, con tendencia a vibraciones.

Presenta gran resistencia al ozono, agentes oxidantes y al envejecimiento térmico.

Notas:
No se recomienda su uso para el transporte de partículas abrasivas.
Otras medidas de longitud existentes.

Construcción

Silicón AHE con refuerzo de poliéster o aramida.

Refuerzos

3 o 4 capas (estándar).

Temperatura

Refuerzo Poliéster
(-55°C a 176°C) (-67°F a 350°F)

Refuerzo Aramida
(-55°C a 260°C) (-67°F a 500°F)

Certificación

Cumple y excede las especificaciones de la Norma SAE J20R1 Clase A.

Longitud

3" pulgadas, medida estándar.
Opción con reducción.



No. De parte AHE	Diámetro interno	Longitud	Capas	Presión de trabajo PSI min	Presión de ruptura PSI min
AHPH33200-3BL	2"	3"	3	75	299
AHPH33225-3BL	2 1/4"	3"	3	63	250
AHPH33250-3BL	2 1/2"	3"	3	56	225
AHPH33275-3BL	2 3/4"	3"	3	50	200
AHPH33300-3BL	3"	3"	3	44	176
AHPH33350-3BL	3 1/2"	3"	3	44	176
AHPH33400-3BL	4"	3"	3	37	149
AHPH33450-3BL	4 1/2"	3"	3	31	125
AHPH46200-3BL	2"	3"	4	88	350
AHPH46225-3BL	2 1/4"	3"	4	75	299
AHPH46250-3BL	2 1/2"	3"	4	63	250
AHPH46275-3BL	2 3/4"	3"	4	63	250
AHPH46300-3BL	3"	3"	4	50	200
AHPH46350-3BL	3 1/2"	3"	4	50	200
AHPH46400-3BL	4"	3"	4	37	149
AHPH46450-3BL	4 1/2"	3"	4	37	149

Joroba con Reducción

No. De parte AHE	D I 1	D I 2	Longitud	Capas	Presión de trabajo PSI min	Presión de ruptura PSI min
AHPH33250/300-3BL	2 1/2"	3"	3"	3	75	299
AHPH33275/300-3BL	2 3/4"	3"	3"	3	63	250
AHPH33300/350-3BL	3"	3 1/2"	3"	3	56	225
AHPH46250/300-3BL	2 1/2"	3"	3"	4	50	200
AHPH46275/300-3BL	2 3/4"	3"	3"	4	44	176
AHPH46300/350-3BL	3"	3 1/2"	3"	4	44	176

Manguera de Calefacción

Mangueras de silicón con refuerzo Poliéster



Manguera lisa de Silicón con tejido de poliéster para servicio pesado.

Especialmente recomendada para sistemas de refrigeración y/o calefacción, en autobuses y camiones.

Excelente resistencia al envejecimiento térmico, y agentes oxidantes (ozono, oxígeno, UV).

Notas.
No se recomienda su uso para el transporte de partículas abrasivas.

Construcción

Fabricada por extrusión con refuerzo de poliéster en el interior, exterior de Silicón AHE.

Refuerzos

Tejido de poliéster.

Temperatura

(-55°C a 176°C)
(-67°F a 350°F)

Certificación

Excede la Norma SAE J20 R3, CLASE A

Presentación

Rollo 25 pies: 1/4", 5/16", 3/8", 1/2", 5/8", 3/4",
7/8", 1", 1 1/4"

Rollo 50 pies: 1 1/4"

Rollo 250 pies: 1/4", 5/16", 3/8", 5/8", 1/2"

Rollo 200 pies: 3/4"

Rollo 100 pies: 7/8"

Rollo 150 pies: 1"

Colores

Exterior azul, interior rojo.

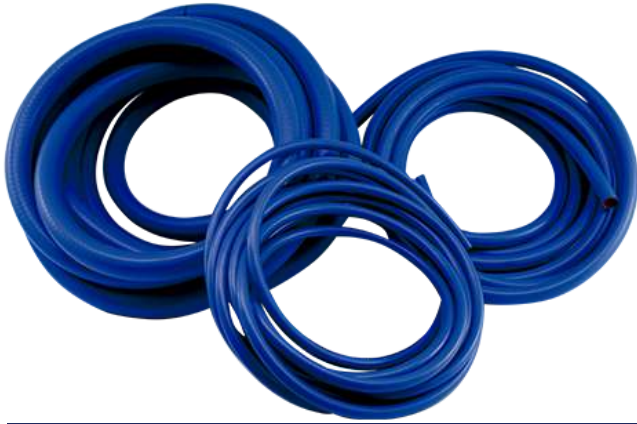

No. De parte AHE	Diámetro nominal en pulgadas	Diámetro interno / Diámetro externo	Diámetro nominal milímetros	Presión de trabajo PSI / BAR	Presión de ruptura PSI / BAR
AHH250	1/4"	.250 / .540	6	88 / 6.1	250 / 17.2
AHH312	5/16"	.312 / .592	8	88 / 6.1	250 / 17.2
AHH375	3/8"	.375 / .675	10	75 / 5.2	250 / 17.2
AHH500	1/2"	.500 / .800	13	75 / 5.2	250 / 17.2
AHH625	5/8"	.625 / .925	16	75 / 5.2	250 / 17.2
AHH750	3/4"	.750 / 1.07	19	63 / 4.4	200 / 13.8
AHH875	7/8"	.875 / 1.22	22	56 / 3.9	175 / 12
AHH1000	1"	1.00 / 1.34	.25	56 / 3.9	175 / 12
AHH1250	1 1/4"	1.25 / 1.63	.28	56 / 3.9	175 / 12

Notas:

Para presentación en caja con rollo de 25 pies, agregar -25 al final del número de parte. Ejemplo: AHH375-25.



Manguera de Vacío

Mangueras flexible de silicón



Manguera lisa de Silicón sin refuerzos textiles.

Recomendada para aire y conducción de fluidos auxiliares por su flexibilidad y tamaño reducido, como en válvulas de descarga, circuito de limpiarabrisas y control de emisiones en vehículos.

Adecuada también para el sector industrial.

Extrema resistencia a condiciones ambientales, envejecimiento térmico y agentes oxidantes: oxígeno, ozono, UV.

Nota:
No se recomienda su uso para el transporte de partículas abrasivas.

Construcción

Silicón AHE.

Refuerzos

Sin refuerzo.

Temperatura

(-53°C a 176°C)
(-65°F a 350°F)

Certificación

Excede la Norma SAE J20 CLASE A.

Medidas

Diámetro interior de 1/8", 3/16", 1/4", 5/16", 3/8" y 3/4"

Color

Azul y rojo.

Presentación

Rollo de 100 pies en todas las medidas.



No. De parte AHE	D I	Medida Nominal pulg/mm	Pared de tubo pulg./mm	Peso de la manguera Lb/Ft	Peso de la manguera Kg/M
AVH125-100	1/8"	.125 / 3.2	.050 / 1.3	0.0159	0.024
AVH187-100	3/16"	.188 / 4.8	.080 / 2.0	0.0389	0.058
AVH250-100	1/4"	.250 / 6.4	.100 / 2.5	0.0635	0.094
AVH312-100	5/16"	.313 / 8.0	.125 / 3.2	0.0993	0.148
AVH375-100	3/8"	.375 / 9.5	.150 / 3.8	0.1429	0.212
AVH750-100	3/4"	.750 / 19.1	.150 / 3.8	0.2449	0.364

Notas:

Otros colores disponibles sobre pedido a partir de 2,000 pies.



Manguera de teflón

Mangueras PTFE o SW.

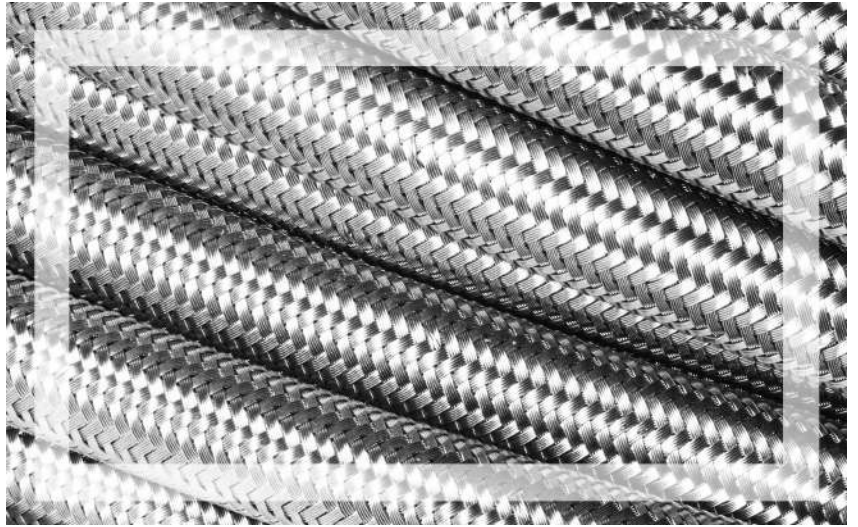

Manguera de PTFE (teflón) recubierta con acero inoxidable trenzado. Debido a su versatilidad, puede aplicarse en industrias como:

- Automotriz
- Farmacéutica
- Petroquímica
- Alimenticia

Por sus propiedades, es inerte y altamente resistente a los productos químicos, funciona bajo alta presión y condiciones de flexión y vibración continuas. Puede transportar líquidos altamente corrosivos, combustible, gases, lubricantes, etc.

Es antiadherente, posee un coeficiente de 0.05 de fricción, lo que asegura la pureza de cualquier fluido, impidiendo que cualquier partícula pueda acumularse, por lo que su flujo es óptimo durante su vida útil.

Carece de afinidad con la humedad, Su nivel de absorción es de 0.01%.

No agrega olor, sabor o color al fluido de transferencia, lo que lo convierte en un material aprobado por la FDA para el contacto con los alimentos.

El PTFE no envejece, por lo que su vida útil es ilimitada.

Construcción

Tubo PTFE liso natural con cubierta de alambre de acero inoxidable trenzado, serie 300.

Rango de Temperatura

Uso intermitente:

(-73°C a 260°C) (-100°F a 475°F)

Uso continuo:

(-54°C a 232°C) (-65°F a 450°F)

Certificación

Cumple y Excede las Especificaciones de la Norma SAE 100 R14.



No. De parte AHE	Tamaño de manguera	Diámetro interno	Diámetro externo	Presión de trabajo (PSI)	Presión de ruptura (PSI)
ATH-4	3/16"	.187	.300	3,000	12,000
ATH-5	1/4"	.260	.375	3,000	12,000
ATH-6	5/16"	.312	.440	2,500	10,000
ATH-8	13/32"	.420	.549	2,000	8,000
ATH-10	1/2"	.510	.648	1,750	6,000
ATH-12	5/8"	.625	.778	1,270	4,800
ATH-16	7/8"	.875	1.030	900	4,000





CONEXIONES DE LATÓN



Conexiones de latón



No. de parte AHE	Descripción
------------------	-------------

CODO 90° HEMBRA- ROSCA

ABF100B-02-02	CODO HEMBRA 90° 1/8 x 1/8
ABF100B-04-04	CODO HEMBRA 90° 1/4 x 1/4
ABF100B-06-06	CODO HEMBRA 90° 3/8 x 3/8
ABF100B-08-08	CODO HEMBRA 90° 1/2 x 1/2

TEE UNIÓN

ABF101B-02	TEE UNION 1/8
ABF101B-04	TEE UNION 1/4
ABF101B-06	TEE UNION 3/8
ABF101B-08	TEE UNION 1/2

CRUZ

ABF102B-02	CRUZ 1/8
ABF102B-04	CRUZ 1/4
ABF102B-06	CRUZ 3/8

COPLÉ

ABF103B-02	COPLÉ 1/8
------------	-----------

TAPON HEMBRA

ABF108B-02	TAPON HEMBRA 1/8
ABF108B-04	TAPON HEMBRA 1/4

TAPON MACHO CABEZA CUADRADA

ABF109B-02	TAPON CABEZA CUADRADA 1/8
ABF109B-04	TAPON CABEZA CUADRADA 1/4
ABF109B-06	TAPON CABEZA CUADRADA 3/8
ABF109B-08	TAPON CABEZA CUADRADA 1/2

REDUCCIÓN BUSHING

ABF110B-04-02	BUSHING 1/4 x 1/8
ABF110B-06-02	BUSHING 3/8 x 1/8
ABF110B-06-04	BUSHING 3/8 x 1/4
ABF110B-12-08	BUSHING 3/4 x 1/2



No. de parte AHE	Descripción
------------------	-------------

CONTRA TUERCA

ABF111B-02	CONTRA TUERCA 1/8
ABF111B-04	CONTRA TUERCA 1/4
ABF111B-06	CONTRA TUERCA 3/8
ABF111B-08	CONTRA TUERCA 1/2

NIPLE CORTO

ABF112B-02	NIPLE CORTO 1/8
ABF112B-04	NIPLE CORTO 1/4
ABF112B-06	NIPLE CORTO 3/8
ABF112B-08	NIPLE CORTO 1/2

NIPLE LARGO

ABF113B-02-24	NIPLE LARGO 1/8 x 1 1/2
ABF113B-02-32	NIPLE LARGO 1/8 x 2
ABF113B-02-40	NIPLE LARGO 1/8 x 2 1/2
ABF113B-02-48	NIPLE LARGO 1/8 x 3
ABF113B-04-24	NIPLE LARGO 1/4 x 1 1/2
ABF113B-04-32	NIPLE LARGO 1/4 x 2
ABF113B-04-40	NIPLE LARGO 1/4 x 2 1/2
ABF113B-04-48	NIPLE LARGO 1/4 x 3
ABF113B-04-56	NIPLE LARGO 1/4 x 3 1/2
ABF113B-04-64	NIPLE LARGO 1/4 x 4
ABF113B-06-24	NIPLE LARGO 3/8 x 1 1/2
ABF113B-06-32	NIPLE LARGO 3/8 x 2
ABF113B-06-40	NIPLE LARGO 3/8 x 2 1/2
ABF113B-06-48	NIPLE LARGO 3/8 x 3
ABF113B-06-56	NIPLE LARGO 3/8 x 3 1/2
ABF113B-08-24	NIPLE LARGO 1/2 x 1 1/2
ABF113B-08-32	NIPLE LARGO 1/2 x 2
ABF113B-08-40	NIPLE LARGO 1/2 x 2 1/2
ABF113B-08-48	NIPLE LARGO 1/2 x 3



No. de parte AHE Descripción

CODO 90° TERMINAL MACHO-HEMBRA

ABF116B-02-02	CODO 90° MACHO - HEMBRA 1/8 x 1/8
ABF116B-04-02	CODO 90° MACHO - HEMBRA 1/4 x 1/8
ABF116B-04-04	CODO 90° MACHO - HEMBRA 1/4 x 1/4
ABF116B-06-06	CODO 90° MACHO - HEMBRA 3/8 x 3/8
ABF116B-08-08	CODO 90° MACHO - HEMBRA 1/2 x 1/2



REDUCCIÓN HEMBRA

ABF119B-04-02	COPLEREDUCCION 1/4 x 1/8
ABF119B-06-04	COPLEREDUCCION 3/8 x 1/4
ABF119B-08-04	COPLEREDUCCION 1/2 x 1/4
ABF119B-08-06	COPLEREDUCCION 1/2 x 3/8
ABF119B-12-08	COPLEREDUCCION 3/4 x 1/2



ADAPTADOR

ABF120B-02-02	ADAPTADOR 1/8 x 1/8
ABF120B-04-02	ADAPTADOR 1/4 x 1/8
ABF120B-04-04	ADAPTADOR 1/4 x 1/4
ABF120B-06-02	ADAPTADOR 3/8 x 1/8
ABF120B-06-04	ADAPTADOR 3/8 x 1/4
ABF120B-06-06	ADAPTADOR 3/8 x 3/8
ABF120B-08-04	ADAPTADOR 1/2 x 1/4
ABF120B-08-06	ADAPTADOR 1/2 x 3/8
ABF120B-08-08	ADAPTADOR 3/8 x 3/8



TAPON MACHO CABEZA HEXAGONAL

ABF121B-02	TAPON CABEZA HEXAGONAL 1/8
ABF121B-04	TAPON CABEZA HEXAGONAL 1/4
ABF121B-06	TAPON CABEZA HEXAGONAL 3/8
ABF121B-08	TAPON CABEZA HEXAGONAL 1/2
ABF121B-12	TAPON CABEZA HEXAGONAL 3/4



NIPLE HEXAGONAL

ABF122B-02-02	NIPLE HEXAGONAL 1/8 x 1/8
ABF122B-04-04	NIPLE HEXAGONAL 1/4 x 1/4
ABF122B-08-08	NIPLE HEXAGONAL 1/2 X 1/2



CODO 45° TERMINAL MACHO - HEMBRA

ABF124B-02-02	CODO 45° MACHO - HEMBRA 1/8 x 1/8
ABF124B-04-04	CODO 45° MACHO - HEMBRA 1/4 x 1/4
ABF124B-06-06	CODO 45° MACHO - HEMBRA 3/8 x 3/8
ABF124B-08-08	CODO 45° MACHO - HEMBRA 1/2 X 1/2



No. de parte AHE	Descripción
------------------	-------------

TEE TERMINAL LATERAL

ABF127B-02	TEE MACHO LATERAL 1/8
ABF127B-04	TEE MACHO LATERAL 1/4
ABF127B-06	TEE MACHO LATERAL 3/8
ABF127B-08	TEE MACHO LATERAL 1/2



COPE PARA MAMPARA

ABF129B-04-24	COPE PARA MAMPARA 1/4 x 1 1/2
ABF129B-06-21	COPE PARA MAMPARA 3/8 X 1 5/16
ABF129B-08-24	COPE PARA MAMPARA 1/2 X 1 1/2



TUERCA CÓNICA CORTA

ABF41FS-04	TUERCA CORTA 1/4
ABF41FS-05	TUERCA CORTA 5/16
ABF41FS-06	TUERCA CORTA 3/8
ABF41FS-08	TUERCA CORTA 1/2
ABF41FS-10	TUERCA CORTA 5/8
ABF41FS-12	TUERCA CORTA 3/4



TUERCA CABEZA HEXAGONAL

ABF41WB-02	TUERCA 1/8
ABF41WB-03	TUERCA 3/16
ABF41WB-04	TUERCA 1/4
ABF41WB-05	TUERCA 5/16
ABF41WB-06	TUERCA 3/8



NIPLE UNIÓN

ABF42F-04	UNION 1/4
ABF42F-05	UNION 5/16
ABF42F-06	UNION 3/8
ABF42F-08	UNION 1/2
ABF42F-10	UNION 5/8
ABF42F-12	UNION 3/4



UNIÓN INVERTIDO

ABF42W-02	UNION 1/8
ABF42W-03	UNION 3/16
ABF42W-04	UNION 1/4
ABF42W-05	UNION 5/16
ABF42W-06	UNION 3/8



No. de parte AHE	Descripción
------------------	-------------

INSERTO

ABF4-459F-04	INSERTO 1/4
ABF4-459F-06	INSERTO 3/8
ABF4-459F-08	INSERTO 1/2
ABF4-459F-10	INSERTO 5/8
ABF4-459F-12	INSERTO 3/4

BARRIL

ABF4-460F-04	BARRIL 1/4
ABF4-460F-06	BARRIL 3/8
ABF4-460F-08	BARRIL 1/2
ABF4-460F-10	BARRIL 5/8
ABF4-460F-12	BARRIL 3/4

TUERCA

ABF4-461F-04	TUERCA 1/4
ABF4-461F-06	TUERCA 3/8
ABF4-461F-08	TUERCA 1/2
ABF4-461F-10	TUERCA 5/8

UNIÓN - FRENOS DE AIRE NYLON

ABF4-462F-04	UNION 1/4
ABF4-462F-06	UNION 3/8
ABF4-462F-08	UNION 1/2
ABF4-462F-10	UNION 5/8
ABF4-462F-12	UNION 3/4

TEE UNIÓN - FRENOS DE AIRE NYLON

ABF4-464F-04	TEE UNION 1/4
ABF4-464F-06	TEE UNION 3/8
ABF4-464F-08	TEE UNION 1/2
ABF4-464F-10	TEE UNION 5/8



No. de parte AHE	Descripción
------------------	-------------

CONECTOR MACHO - FRENOS DE AIRE NYLON

ABF4-468F-04-02	CONECTOR MACHO 1/4 x 1/8
ABF4-468F-04-04	CONECTOR MACHO 1/4 x 1/4
ABF4-468F-04-06	CONECTOR MACHO 1/4 x 3/8
ABF4-468F-06-02	CONECTOR MACHO 3/8 x 1/8
ABF4-468F-06-04	CONECTOR MACHO 3/8 x 1/4
ABF4-468F-06-06	CONECTOR MACHO 3/8 x 3/8
ABF4-468F-06-08	CONECTOR MACHO 3/8 x 1/2
ABF4-468F-08-04	CONECTOR MACHO 1/2 x 1/4
ABF4-468F-08-06	CONECTOR MACHO 1/2 x 3/8
ABF4-468F-08-08	CONECTOR MACHO 1/2 x 1/2
ABF4-468F-10-06	CONECTOR MACHO 5/8 x 3/8
ABF4-468F-10-08	CONECTOR MACHO 5/8 x 1/2
ABF4-468F-12-08	CONECTOR MACHO 3/4 x 1/2
ABF4-468F-12-12	CONECTOR MACHO 3/4 x 3/4



CODO 90° TERMINAL MACHO - FRENOS DE AIRE NYLON

ABF4-469F-04-02	CODO MACHO 1/4 x 1/8
ABF4-469F-04-04	CODO MACHO 1/4 x 1/4
ABF4-469F-04-06	CODO MACHO 1/4 x 3/8
ABF4-469F-06-02	CODO MACHO 3/8 x 1/8
ABF4-469F-06-04	CODO MACHO 3/8 x 1/4
ABF4-469F-06-06	CODO MACHO 3/8 x 3/8
ABF4-469F-06-08	CODO MACHO 3/8 x 1/2
ABF4-469F-08-04	CODO MACHO 1/2 x 1/4
ABF4-469F-08-06	CODO MACHO 1/2 x 3/8
ABF4-469F-08-08	CODO MACHO 1/2 x 1/2
ABF4-469F-10-06	CODO MACHO 5/8 x 3/8
ABF4-469F-10-08	CODO MACHO 5/8 x 1/2
ABF4-469F-12-08	CODO MACHO 3/4 x 1/2



No. de parte AHE Descripción

CODO 90° TERMINAL HEMBRA - FRENOS DE AIRE NYLON

ABF4-470F-04-02	CODO 90° HEMBRA 1/4 x 1/8
ABF4-470F-06-02	CODO 90° HEMBRA 3/8 x 1/8
ABF4-470F-06-04	CODO 90° HEMBRA 3/8 x 1/4
ABF4-470F-06-06	CODO 90° HEMBRA 3/8 x 3/8
ABF4-470F-08-06	CODO 90° HEMBRA 1/2 x 3/8
ABF4-470F-08-08	CODO 90° HEMBRA 1/2 x 1/2
ABF4-470F-10-08	CODO 90° HEMBRA 5/8 x 1/2



TEE MACHO LATERAL

ABF4-471F-04-04	TEE MACHO LATERAL 1/4 x 1/4
ABF4-471F-06-04	TEE MACHO LATERAL 3/8 x 1/4
ABF4-471F-06-06	TEE MACHO LATERAL 3/8 x 3/8
ABF4-471F-08-06	TEE MACHO LATERAL 1/2 x 3/8
ABF4-471F-10-08	TEE MACHO LATERAL 5/8 x 1/2



TEE MACHO AL CENTRO

ABF4-472F-04-02	TEE MACHO AL CENTRO 1/4 x 1/8
ABF4-472F-04-04	TEE MACHO AL CENTRO 1/4 x 1/4
ABF4-472F-06-02	TEE MACHO AL CENTRO 3/8 x 1/8
ABF4-472F-06-04	TEE MACHO AL CENTRO 3/8 x 1/4
ABF4-472F-06-06	TEE MACHO AL CENTRO 3/8 x 3/8
ABF4-472F-08-06	TEE MACHO AL CENTRO 1/2 x 3/8
ABF4-472F-08-08	TEE MACHO AL CENTRO 1/2 x 1/2
ABF4-472F-10-08	TEE MACHO AL CENTRO 5/8 x 1/2



CODO 45° MACHO

ABF4-474F-08-06	CODO 45° 1/2 x 3/8
ABF4-474F-10-08	CODO 45° 5/8 x 1/2



TEE UNIÓN ABOCINADO A 45°

ABF44F-02	TEE UNION 1/8
ABF44F-04	TEE UNION 1/4
ABF44F-05	TEE UNION 5/16
ABF44F-06	TEE UNION 3/8
ABF44F-08	TEE UNION 1/2
ABF44F-10	TEE UNION 5/8



No. de parte AHE	Descripción
------------------	-------------

TEE UNIÓN INVERTIDO

ABF44W-03	TEE UNION 3/16
ABF44W-04	TEE UNION 1/4
ABF44W-05	TEE UNION 5/16



TEE TERMINAL MACHO AL CENTRO

ABF45F-04-02	TEE MACHO AL CENTRO 1/4 x 1/8
ABF45F-04-04	TEE MACHO AL CENTRO 1/4 x 1/4
ABF45F-05-02	TEE MACHO AL CENTRO 5/16 x 1/8
ABF45F-05-04	TEE MACHO AL CENTRO 5/16 x 1/4
ABF45F-06-04	TEE MACHO AL CENTRO 3/8 x 1/4
ABF45F-08-06	TEE MACHO AL CENTRO 1/2 x 3/8
ABF45F-08-08	TEE MACHO AL CENTRO 1/2 x 1/2
ABF45F-10-08	TEE MACHO AL CENTRO 5/8 x 1/2



BARRIL - FRENOS DE AIRE COBRE

ABF460F-04	BARRIL 1/4
ABF460F-06	BARRIL 3/8
ABF460F-08	BARRIL 1/2
ABF460F-10	BARRIL 5/8
ABF460F-12	BARRIL 3/4



TUERCA - FRENOS DE AIRE COBRE

ABF461F-04	TUERCA 1/4
ABF461F-06	TUERCA 3/8
ABF461F-08	TUERCA 1/2
ABF461F-10	TUERCA 5/8
ABF461F-12	TUERCA 3/4



UNIÓN - FRENOS DE AIRE COBRE

ABF462F-04	UNION 1/4
ABF462F-06	UNION 3/8
ABF462F-08	UNION 1/2
ABF462F-10	UNION 5/8
ABF462F-12	UNION 3/4



No. de parte AHE	Descripción
------------------	-------------

TEE UNIÓN - FRENOS DE AIRE COBRE

ABF464F-04	TEE UNION 1/4
ABF464F-06	TEE UNION 3/8
ABF464F-08	TEE UNION 1/2
ABF464F-10	TEE UNION 5/8



CONECTOR HEMBRA - FRENOS DE AIRE COBRE

ABF466F-04-04	CONECTOR HEMBRA 1/4 x 1/4
ABF466F-06-02	CONECTOR HEMBRA 3/8 x 1/8
ABF466F-06-06	CONECTOR HEMBRA 3/8 x 3/8
ABF466F-08-08	CONECTOR HEMBRA 1/2 x 1/2



CONECTOR MACHO - FRENOS DE AIRE COBRE

ABF468F-04-04	CONECTOR MACHO 1/4 x 1/4
ABF468F-04-06	CONECTOR MACHO 1/4 x 3/8
ABF468F-06-02	CONECTOR MACHO 3/8 x 1/8
ABF468F-06-06	CONECTOR MACHO 3/8 x 3/8
ABF468F-06-08	CONECTOR MACHO 3/8 x 1/2
ABF468F-08-04	CONECTOR MACHO 1/2 x 1/4
ABF468F-08-08	CONECTOR MACHO 1/2 x 1/2
ABF468F-10-06	CONECTOR MACHO 5/8 x 3/8



CODO 90° TERMINAL MACHO - FRENOS DE AIRE COBRE

ABF469F-04-02	CODO MACHO 90° 1/4 x 1/8
ABF469F-04-04	CODO MACHO 90° 1/4 x 1/4
ABF469F-04-06	CODO MACHO 90° 1/4 x 3/8
ABF469F-06-02	CODO MACHO 90° 3/8 x 1/8
ABF469F-06-04	CODO MACHO 90° 3/8 x 1/4
ABF469F-06-06	CODO MACHO 90° 3/8 x 3/8
ABF469F-06-08	CODO MACHO 90° 3/8 x 1/2
ABF469F-08-06	CODO MACHO 90° 1/2 x 3/8
ABF469F-08-08	CODO MACHO 90° 1/2 x 1/2
ABF469F-10-06	CODO MACHO 90° 5/8 x 3/8



No. de parte AHE	Descripción
------------------	-------------

CAMPANA NIPLE HEMBRA

ABF46F-03-02	CONECTOR HEMBRA 3/16 x 1/8
ABF46F-04-02	CONECTOR HEMBRA 1/4 x 1/8
ABF46F-04-04	CONECTOR HEMBRA 1/4 x 1/4
ABF46F-04-06	CONECTOR HEMBRA 1/4 x 3/8
ABF46F-05-02	CONECTOR HEMBRA 5/16 x 1/8
ABF46F-05-04	CONECTOR HEMBRA 5/16 x 1/4
ABF46F-06-02	CONECTOR HEMBRA 3/8 x 1/8
ABF46F-06-04	CONECTOR HEMBRA 3/8 x 1/4
ABF46F-06-06	CONECTOR HEMBRA 3/8 x 3/8
ABF46F-06-08	CONECTOR HEMBRA 3/8 x 1/2
ABF46F-06-12	CONECTOR HEMBRA 3/8 x 3/4
ABF46F-08-04	CONECTOR HEMBRA 1/2 x 1/4
ABF46F-08-06	CONECTOR HEMBRA 1/2 x 3/8
ABF46F-08-08	CONECTOR HEMBRA 1/2 x 1/2
ABF46F-10-06	CONECTOR HEMBRA 5/16 x 3/8
ABF46F-10-08	CONECTOR HEMBRA 5/16 x 1/2



CONECTOR HEMBRA

ABF46W-03-02	CONECTOR HEMBRA 3/16 x 1/8
ABF46W-04-02	CONECTOR HEMBRA 1/4 x 1/8
ABF46W-05-02	CONECTOR HEMBRA 5/16 x 1/8
ABF46W-06-04	CONECTOR HEMBRA 3/8 x 1/4



TEE MACHO LATERAL ROSCA - FRENOS DE AIRE COBRE

ABF471F-04-02	TEE MACHO LATERAL 1/4 x 1/8
ABF471F-06-04	TEE MACHO LATERAL 3/8 x 1/4
ABF471F-08-06	TEE MACHO LATERAL 1/2 x 3/8
ABF471F-10-08	TEE MACHO LATERAL 5/8 x 1/2



TEE MACHO AL CENTRO - FRENOS AIRE COBRE

ABF472F-04-02	TEE MACHO AL CENTRO 1/4 x 1/8
ABF472F-04-04	TEE MACHO AL CENTRO 1/4 x 1/4
ABF472F-06-04	TEE MACHO AL CENTRO 3/8 x 1/4
ABF472F-08-06	TEE MACHO AL CENTRO 1/2 x 3/8

No. de parte AHE	Descripción
------------------	-------------

NIPLE TERMINAL MACHO

ABF48F-04-02	CONECTOR MACHO 1/4 x 1/8
ABF48F-04-04	CONECTOR MACHO 1/4 x 1/4
ABF48F-04-06	CONECTOR MACHO 1/4 x 3/8
ABF48F-04-08	CONECTOR MACHO 1/4 x 1/2
ABF48F-05-02	CONECTOR MACHO 5/16 x 1/8
ABF48F-05-04	CONECTOR MACHO 5/16 x 1/4
ABF48F-06-02	CONECTOR MACHO 3/8 x 1/8
ABF48F-06-04	CONECTOR MACHO 3/8 x 1/4
ABF48F-06-06	CONECTOR MACHO 3/8 x 3/8
ABF48F-06-08	CONECTOR MACHO 3/8 x 1/2
ABF48F-06-12	CONECTOR MACHO 3/8 x 3/4
ABF48F-08-04	CONECTOR MACHO 1/2 x 1/4
ABF48F-08-06	CONECTOR MACHO 1/2 x 3/8
ABF48F-08-08	CONECTOR MACHO 1/2 x 1/2
ABF48F-08-12	CONECTOR MACHO 1/2 x 3/4
ABF48F-10-04	CONECTOR MACHO 5/8 x 1/4
ABF48F-10-06	CONECTOR MACHO 5/8 x 3/8
ABF48F-10-08	CONECTOR MACHO 5/8 x 1/2
ABF48F-10-12	CONECTOR MACHO 5/8 x 3/4
ABF48F-12-08	CONECTOR MACHO 3/4 x 1/2
ABF48F-12-12	CONECTOR MACHO 3/4 x 3/4



CONECTOR MACHO INVERTIDO

ABF48W-03-02	CONECTOR MACHO 3/16 x 1/8
ABF48W-04-02	CONECTOR MACHO 1/4 x 1/8
ABF48W-04-04	CONECTOR MACHO 1/4 x 1/4
ABF48W-05-02	CONECTOR MACHO 5/16 x 1/8
ABF48W-05-04	CONECTOR MACHO 5/16 x 1/4
ABF48W-06-02	CONECTOR MACHO 3/8 x 1/8
ABF48W-06-04	CONECTOR MACHO 3/8 x 1/4
ABF48W-06-06	CONECTOR MACHO 3/8 x 3/8
ABF48W-08-04	CONECTOR MACHO 1/2 x 1/4
ABF48W-08-06	CONECTOR MACHO 1/2 x 3/8
ABF48W-10-08	CONECTOR MACHO 5/8 x 1/2

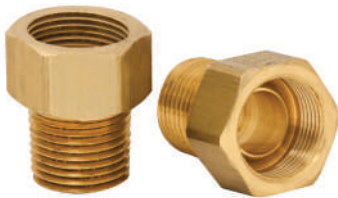

No. de parte AHE	Descripción
------------------	-------------

CODO 90° TERMINAL MACHO



ABF49F-03-02	CODO MACHO 90° 3/16 x 1/8
ABF49F-04-02	CODO MACHO 90° 1/4 x 1/8
ABF49F-04-04	CODO MACHO 90° 1/4 x 1/4
ABF49F-04-06	CODO MACHO 90° 1/4 x 3/8
ABF49F-05-02	CODO MACHO 90° 5/16 x 1/8
ABF49F-05-04	CODO MACHO 90° 5/16 x 1/4
ABF49F-05-06	CODO MACHO 90° 5/16 X 3/8
ABF49F-06-02	CODO MACHO 90° 3/8 x 1/8
ABF49F-06-04	CODO MACHO 90° 3/8 x 1/4
ABF49F-06-06	CODO MACHO 90° 3/8 x 3/8
ABF49F-06-08	CODO MACHO 90° 3/8 x 1/2
ABF49F-08-04	CODO MACHO 90° 1/2 x 1/4
ABF49F-08-06	CODO MACHO 90° 1/2 x 3/8
ABF49F-08-08	CODO MACHO 90° 1/2 x 1/2
ABF49F-08-12	CODO MACHO 90° 1/2 X 3/4
ABF49F-10-06	CODO MACHO 90° 5/8 x 3/8
ABF49F-10-08	CODO MACHO 90° 5/8 x 1/2
ABF49F-12-08	CODO MACHO 90° 3/4 x 1/2
ABF49F-12-12	CODO MACHO 90° 3/4 x 3/4

CODO 90° TERMINAL MACHO INVERTIDO



ABF49W-03-02	CODO MACHO 90° 3/16 x 1/8
ABF49W-04-02	CODO MACHO 90° 1/4 x 1/8
ABF49W-04-04	CODO MACHO 90° 1/4 x 1/4
ABF49W-05-02	CODO MACHO 90° 5/16 x 1/8
ABF49W-05-04	CODO MACHO 90° 5/16 x 1/4
ABF49W-06-02	CODO MACHO 90° 3/8 x 1/8
ABF49W-06-04	CODO MACHO 90° 3/8 x 1/4
ABF49W-06-06	CODO MACHO 90° 3/8 x 3/8
ABF49W-08-06	CODO MACHO 90° 1/2 x 3/8

No. de parte AHE	Descripción
------------------	-------------

CODO 90° TERMINAL HEMBRA



ABF50F-04-02	CODO 90° HEMBRA 1/4 x 1/8
ABF50F-04-04	CODO 90° HEMBRA 1/4 x 1/4
ABF50F-05-02	CODO 90° HEMBRA 5/16 x 1/8
ABF50F-05-04	CODO 90° HEMBRA 5/16 x 1/4
ABF50F-06-04	CODO 90° HEMBRA 3/8 x 1/4
ABF50F-06-06	CODO 90° HEMBRA 3/8 x 3/8
ABF50F-06-08	CODO 90° HEMBRA 3/8 x 1/2
ABF50F-08-06	CODO 90° HEMBRA 1/2 x 3/8
ABF50F-08-08	CODO 90° HEMBRA 1/2 x 1/2

TEE TERMINAL MACHO LATERAL



ABF51F-04-04	TEE MACHO LATERAL 1/4 x 1/4
ABF51F-06-04	TEE MACHO LATERAL 3/8 x 1/4
ABF51F-06-06	TEE MACHO LATERAL 3/8 x 3/8
ABF51F-08-06	TEE MACHO LATERAL 1/2 x 3/8
ABF51F-10-08	TEE MACHO LATERAL 5/8 x 1/2

CODO 45° TERMINAL MACHO



ABF54F-04-02	CODO 45° MACHO 1/4 x 1/8
ABF54F-06-04	CODO 45° MACHO 3/8 x 1/4
ABF54F-06-06	CODO 45° MACHO 3/8 x 3/8
ABF54F-08-06	CODO 45° MACHO 1/2 x 3/8
ABF54F-08-08	CODO 45° MACHO 1/2 x 1/2
ABF54F-10-08	CODO 45° MACHO 5/8 x 1/2

CODO 90° UNIÓN



ABF55F-04	CODO 90° UNION 1/4
ABF55F-05	CODO 90° UNION 5/16
ABF55F-06	CODO 90° UNION 3/8
ABF55F-08	CODO 90° UNION 1/2
ABF55F-10	CODO 90° UNION 5/8



No. de parte AHE	Descripción
------------------	-------------

BARRIL COMPRESIÓN

ABF60F-02	BARRIL 1/8
ABF60F-03	BARRIL 3/16
ABF60F-04	BARRIL 1/4
ABF60F-05	BARRIL 5/16
ABF60F-06	BARRIL 3/8
ABF60F-08	BARRIL 1/2
ABF60F-10	BARRIL 5/8
ABF60F-12	BARRIL 3/4



TUERCA COMPRESIÓN

ABF61F-02	TUERCA 1/8
ABF61F-03	TUERCA 3/16
ABF61F-04	TUERCA 1/4
ABF61F-05	TUERCA 5/16
ABF61F-06	TUERCA 3/8
ABF61F-08	TUERCA 1/2
ABF61F-10	TUERCA 5/8
ABF61F-12	TUERCA 3/4



UNIÓN COMPRESIÓN

ABF62F-02	UNION 1/8
ABF62F-03	UNION 3/16
ABF62F-04	UNION 1/4
ABF62F-05	UNION 5/16
ABF62F-06	UNION 3/8
ABF62F-08	UNION 1/2
ABF62F-10	UNION 5/8
ABF62F-12	UNION 3/4



TEE UNIÓN COMPRESIÓN

ABF64F-02	TEE UNION 1/8
ABF64F-03	TEE UNION 3/16
ABF64F-04	TEE UNION 1/4
ABF64F-05	TEE UNION 5/16
ABF64F-06	TEE UNION 3/8
ABF64F-08	TEE UNION 1/2



No. de parte AHE	Descripción
------------------	-------------

CODO 90° UNIÓN COMPRESIÓN

ABF65F-03	CODO 90° UNIÓN 3/16
ABF65F-04	CODO 90° UNIÓN 1/4
ABF65F-05	CODO 90° UNIÓN 5/16
ABF65F-06	CODO 90° UNIÓN 3/8



CONECTOR HEMBRA COMPRESIÓN

ABF66F-02-02	CONECTOR HEMBRA 1/8 x 1/8
ABF66F-03-02	CONECTOR HEMBRA 3/16 x 1/8
ABF66F-04-02	CONECTOR HEMBRA 1/4 x 1/8
ABF66F-04-04	CONECTOR HEMBRA 1/4 x 1/4
ABF66F-05-02	CONECTOR HEMBRA 5/16 x 1/8
ABF66F-05-04	CONECTOR HEMBRA 5/16 x 1/4
ABF66F-06-02	CONECTOR HEMBRA 3/8 x 1/8
ABF66F-06-04	CONECTOR HEMBRA 3/8 x 1/4
ABF66F-06-06	CONECTOR HEMBRA 3/8 x 3/8
ABF66F-08-06	CONECTOR HEMBRA 1/2 x 3/8
ABF66F-08-08	CONECTOR HEMBRA 1/2 x 1/2
ABF66F-10-08	CONECTOR HEMBRA 5/8 x 1/2



CONECTOR MACHO COMPRESIÓN

ABF68F-02-02	CONECTOR MACHO 1/8 x 1/8
ABF68F-03-02	CONECTOR MACHO 3/16 x 1/8
ABF68F-04-02	CONECTOR MACHO 1/4 x 1/8
ABF68F-04-04	CONECTOR MACHO 1/4 x 1/4
ABF68F-04-06	CONECTOR MACHO 1/4 x 3/8
ABF68F-05-02	CONECTOR MACHO 5/16 x 1/8
ABF68F-05-04	CONECTOR MACHO 5/16 x 1/4
ABF68F-06-02	CONECTOR MACHO 3/8 x 1/8
ABF68F-06-04	CONECTOR MACHO 3/8 x 1/4
ABF68F-06-06	CONECTOR MACHO 3/8 x 3/8
ABF68F-06-08	CONECTOR MACHO 3/8 x 1/2
ABF68F-08-04	CONECTOR MACHO 1/2 x 1/4
ABF68F-08-06	CONECTOR MACHO 1/2 x 3/8
ABF68F-08-08	CONECTOR MACHO 1/2 x 1/2
ABF68F-10-06	CONECTOR MACHO 5/8 x 3/8
ABF68F-10-08	CONECTOR MACHO 5/8 x 1/2
ABF68F-12-08	CONECTOR MACHO 3/4 x 5/8
ABF68F-12-12	CONECTOR MACHO 3/4 x 3/4

No. de parte AHE	Descripción
------------------	-------------

CODO 90° TERMINAL MACHO COMPRESIÓN

ABF69F-02-02	CODO 90° MACHO 1/8 x 1/8
ABF69F-03-02	CODO 90° MACHO 3/16 x 1/8
ABF69F-04-02	CODO 90° MACHO 1/4 x 1/8
ABF69F-04-04	CODO 90° MACHO 1/4 x 1/4
ABF69F-04-06	CODO 90° MACHO 1/4 x 3/8
ABF69F-05-02	CODO 90° MACHO 5/16 x 1/8
ABF69F-05-04	CODO 90° MACHO 5/16 x 1/4
ABF69F-06-02	CODO 90° MACHO 3/8 x 1/8
ABF69F-06-04	CODO 90° MACHO 3/8 x 1/4
ABF69F-06-06	CODO 90° MACHO 3/8 x 3/8
ABF69F-06-08	CODO 90° MACHO 3/8 x 1/2
ABF69F-08-04	CODO 90° MACHO 1/2 x 1/4
ABF69F-08-06	CODO 90° MACHO 1/2 x 3/8
ABF69F-08-08	CODO 90° MACHO 1/2 x 1/2
ABF69F-10-06	CODO 90° MACHO 5/8 x 3/8
ABF69F-10-08	CODO 90° MACHO 5/8 x 1/2



CODO 90° HEMBRA COMPRESIÓN

ABF70F-06-04	CODO 90° HEMBRA 3/8 x 1/4
ABF70F-10-08	CODO 90° HEMBRA 5/8 x 1/2



TEE TERMINAL LATERAL COMPRESIÓN

ABF71F-02-02	TEE MACHO LATERAL 1/8 x 1/8
ABF71F-04-02	TEE MACHO LATERAL 1/4 x 1/8
ABF71F-04-04	TEE MACHO LATERAL 1/4 x 1/4
ABF71F-05-02	TEE MACHO LATERAL 5/16 x 1/8
ABF71F-06-06	TEE MACHO LATERAL 3/8 x 3/8













































RECURSOS

GUÍA RÁPIDA DE CONEXIONES DE LATÓN • NOMENCLATURA AHE

CÓMO INSTALAR UNA ABRAZADERA • CÓMO MEDIR UN CODO • APLICACIONES



GUÍA RÁPIDA PARA IDENTIFICACIÓN DE CONEXIONES DE LATÓN

	Abocinado 45	Abocinado invertido	Frenos de Aire Tubo Cobre	Frenos de Aire Tubo Nylon	Compresión	Rosca para tubo NPTF
	Serie ABF40F	Serie ABF40W	Serie ABF460F	Serie ABF4-460F	Serie ABF60F	Serie ABF100B
Barril			 ABF460F	 ABF4-460F	 ABF60F	 ABF129B
Tuercas	 ABF41F	 ABF41W	 ABF461F	 ABF4-461F	 ABF61F	 ABF110B
Uniones	 ABF42F	 ABF42W	 ABF462F	 ABF4-462F	 ABF62F	 ABF113B
Tes Unión	 ABF44F	 ABF44W	 ABF464F	 ABF4-464F	 ABF64F	 ABF101B
Codo 90 Unión	 ABF55F				 ABF65F	 ABF100B
Conector Hembra FPT	 ABF46F	 ABF46W	 ABF466F		 ABF66F	 ABF103B
Conector Macho NPT	 ABF48F	 ABF48W	 ABF468F	 ABF4-468F	 ABF68F	 ABF120B
Conector Macho NPT 90	 ABF49F	 ABF49W	 ABF469F	 ABF4-469F	 ABF69F	 ABF116B
						 ABF127B

CÓMO IDENTIFICAR EL NÚMERO DE PARTE AHE

El Número de parte es el código de identificación de cada pieza que fabricamos. Es una nomenclatura conformada por las características técnicas y específicas de cada producto: el tipo de manguera, números de capas de silicón, tipo de refuerzo téxtil, medidas, color y terminado; éste último es el aspecto físico o estético de la pieza.

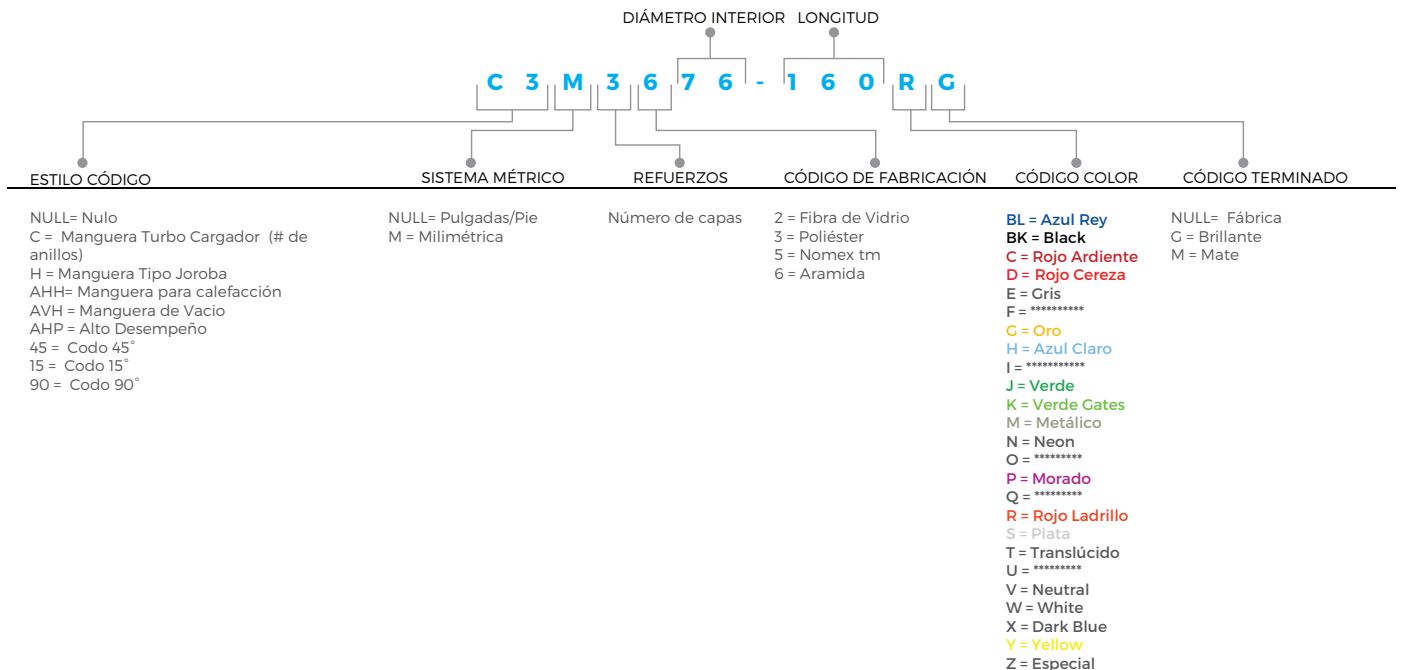

EJEMPLOS:

AHH1000-25

AHH = Manguera para Calefacción
1000 = 1" Diámetro Interior
25 = 25 Pies de Largo = 7.62 metros.

AHP33250-36BL

AHP = Alto Desempeño
3 = Capas
3 = Poliéster
250 = Diámetro Interior 2 1/2"
36 = 36" Largo
BL = Azul

C3M3676-160R

C = Turbo Cargador
3 = 3 Anillos
M = Milimétrica
3 = Capas
6 = Aramida
76 = 76 mm D. Interior
160 = 160mm Largo
R = Rojo ladrillo

AHP9043350-6BL

AHP = Alto Desempeño
90 = Ángulo
4 = Capas
3 = Aramida
350 = 3 1/2" D. Interior
6 = 6" Largo del brazo
BL = Azul

CÓMO COLOCAR UNA ABRAZADERA EN UNA MANGUERA

Para mangueras de silicón sólo utiliza abrazaderas T-Bolt.
Su torque constante ayuda a retener la fuerza o carga y evita la ruptura del material.

Se recomienda torque de 70 a 75 libras por pulgadas.

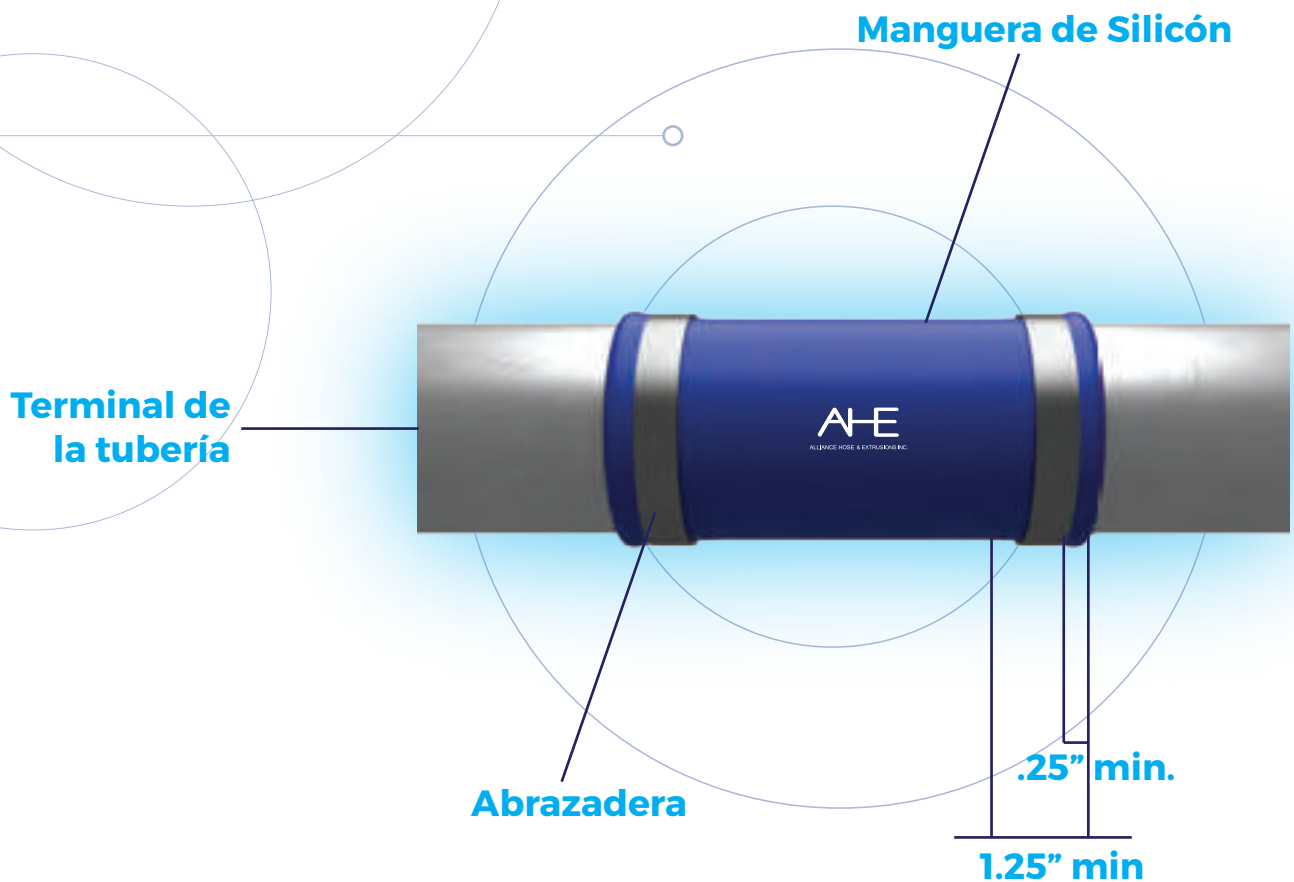

CÓMO MEDIR UN CODO AHE

La longitud de las piernas de un codo debe medirse de acuerdo a las siguientes ilustraciones. Tenga en cuenta que las piernas normalmente se dejan un poco más largas para permitir que nuestros clientes puedan realizar los ajustes finales según sea necesario.

EJEMPLO:

AHP9043300-6BL

90° grados
4 Capas
3 Poliéster
3" Diámetro Interior
6" Longitud de cada pierna

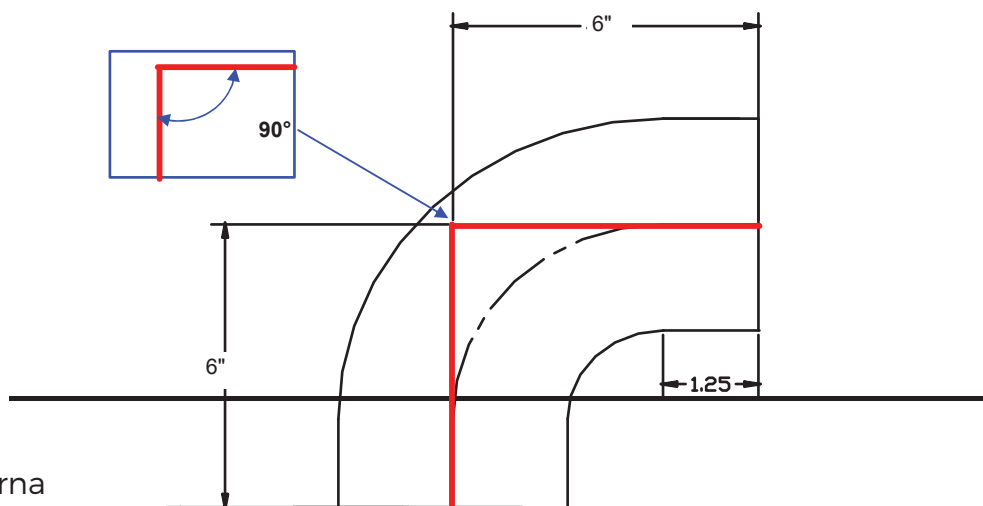

EJEMPLO:

AHP4543300-3BL

45° grados
4 Capas
3 Poliéster
3" Diámetro Interior
3" Longitud de cada pierna

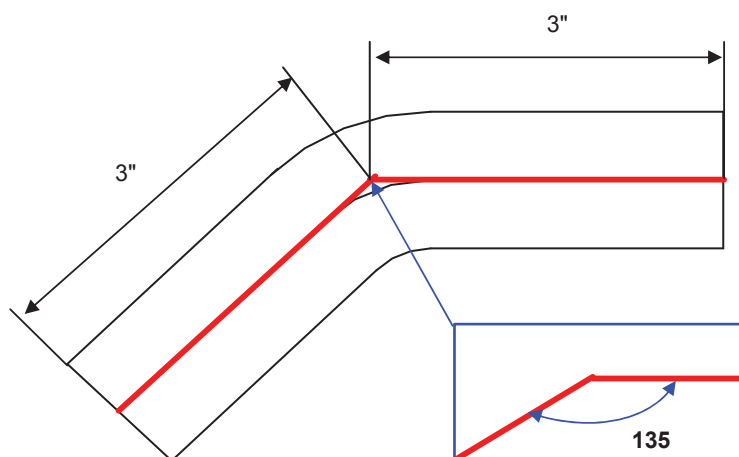

EQUIVALENCIAS ENTRE NÚMEROS DE PARTE AHE Y GATES

LÍNEA DE MANGUERAS MERCEDES BENZ.



No. de Parte AHE	Descripción	Equivalente M. Benz	Modelo	Motor	No. de parte Gates
AHP9043236256-4BK	60/65mm DI . Codo 90°, Negro, 4 capas aramida.	A 001 501 08 82	EvoBus	906 EPA04	41710017
M4689-70R	89x70mm. Naranja, 4 capas aramida.	A 376 094 03 82	XBC	924 EPA04	*****
M4685-70R	85x70mm. Naranja, 4 capas aramida.	A 376 094 70 82	XBC	906 EPA04	*****
M4680-70R-FL	80x70mm. Naranja, 4 capas aramida FSI.	A 382 528 79 82	XBC	906 EPA04	*****
M46100-70R-FL	100x70mm. Naranja, 4 capas aramida FSI.	A 382 528 80 82	XBC	906	*****
M4665-70R	65x70mm. Naranja, 4 capas aramida.	A 476 094 70 82	XBC	906 EPA04	*****
M46100-80R-FL	100x80mm. Naranja, 4 capas aramida, FSI.	A 664 528 76 82	XBC	924 EPA04	*****
M4670-70R-FL	70x70mm. Naranja, 4 capas aramida, FSI.	A 668 528 10 82	XBC	906	*****
M36101.6-73R	101.6x73mm. Naranja, 3 capas aramida.	A 685 528 96 82	OMC	924 EURO3	41710022
M3685-65R	85x65mm. Naranja, 3 capas aramida.	A 904 094 11 82	MBO	924 EPA04	41710009
M3685-82R	85x82mm. Naranja, 3 capas aramida.	A 906 094 03 82	OMC	906	41710010
M3685-90R	85x90mm. Naranja, 3 capas aramida.	A 906 094 09 82	OMC	906	41710005
C3M3676/89-140B	76/89x140mm. Negra, 3 anillos, 3 capas aramida.	A 904 094 05 82	MBO	924 EURO3	41710000
C3M3676/80-140B	76/80x140mm. Negra, 3 anillos, 3 capas aramida.	A 904 094 06 82	MBO	924 EPA04	41710001
C3M3676/80-140R	76/80x140mm. Roja, 3 anillos, 3 capas aramida.	A 904 094 07 82	MBO	924 EPA04	41710002
C3M3676-140R	76x140mm. Roja, 3 anillos, 3 capas aramida.	A 904 094 08 82	MBO	924 EPA04	41710003
C3M3676-140B	76x140mm. Negra, 3 anillos, 3 capas aramida.	A 904 094 09 82	MBO	924 EPA04	*****
C3M3680/85-145B	80/85x145mm. Negra, 3 anillos, 3 capas aramida.	A 906 094 05 82	OMC	906	41710011
C4M4680-155R	80x155mm. Roja, 4 anillos, 4 capas aramida.	A 368 500 01 75	XBC	924 EPA04	*****
C5M4699-197R-FL	99x197mm. Roja, 5 anillos, 3 capas aramida, FSI.	A 001 501 91 82	EvoBus	906 EPA04	*****
C5M3380/85-215B	80/85x215mm. Negra, 5 anillos, 3 capas poliéster.	A 696 500 70 75	XBC	906 EPA04	*****
C5M3380/85-253B-FL	80/85x253mm. Negra, 5 anillos, 3 capas poliéster, FSI.	A 384 501 14 82	XBC	924 EPA04	*****
C5M3680/85-215R	80/85x215. Roja, 5 anillos, 3 capas aramida.	A 696 500 72 75	XBC	907 EPA04	*****
C5M3680/85-215B	80/85x215. Negra, 5 anillos, 3 capas aramida.	A 906 094 06 82	OMC	924 EURO3	41710018
C5M4680/100-225RM	80/100x225mm. Roja Mate, 5 anillos, 4 capas aramida.	A 000 501 91 82	OMC	906	*****
C6M4680/85-215R	80/85x215mm. Roja, 6 anillos, 4 capas aramida.	A 382 500 01 75	XBC	906 EPA04	*****
C7M4680/85-253R	80/85x253mm. Roja, 7 anillos, 4 capas aramida.	A 384 500 07 75	MBC-O	924	*****

COPLES DE SILICÓN

No. de Parte AHE	Código de Fabricación Gates	No. De Parte Gates	D.I.	Longitud
AHP33300-3BL	77340001	26001	3"	3"
AHP33338-3.5BL	77340002	26002	3 3/8"	3.5"
AHP33338-6BL	77340003	26003	3 3/8"	6"
AHP33350-3BL	77340004	26004	3 1/2"	3"



MANGUERA TURBOCARGADOR/POSTENFRIADOR CAC

No. de Parte AHE	Código de Fabricación Gates	No. De Parte Gates	D.I.	Longitud	No. De Anillos
C2M4661/75-136RM	773477345000	SIH61/710136MM2A	61mm / 75mm	136mm	2
C2M4689-140RM	773477345001	SIH890133MM2A	89mm	133mm	2
C3M46102-152R	773477345002	SIH400063A	4"	6"	3
C3M46102-203R	773477345003	SIH40083A	4"	8"	3
C3M3662-160R	773477345004	SIH620160MM3A	62mm	160mm	3
C4M3670-170R	773477345005	SIH700170MM4A	70mm	170mm	4
C5M3680/84-215R	773477345006	SIH80/840215MM5A	80mm / 84mm	215mm	5
C5M3680/100-225RB	773477345007	SIH80/1000225MM5A	80mm / 10mm	255mm	5
C6M4689-215R	773477345008	SIH3500856A	3 1/2"	8 1/2"	6
C6M46102-228R	773477345009	SIH400096A	4"	9"	6
C6M46102-228R	773477345010	SIH1020228MM6A	102mm	228mm	6
C6M4689-215R	773477345011	SIH890215MM6A	89mm	215mm	6
C746400-12.5R	773477345012	SIH4001257A	4"	12 1/2"	7
C8M3689-305R	773477345013	SIH8903057A	89mm	305mm	8
C5M3670-195R	773477342001	SIH2750085A	2 3/4"	2 3/4"	5
C5M4664-216BLM	*****	28359	64mm	216mm	5
C346300-6R	41774000	26200	3"	6"	3
C346350-6R	41770001	26201	3 1/2"	6"	3
C3M46102-152R	41774003	26203	4"	6"	3
C3M46102-203R	41774004	26204	4"	8"	3



CODOS PARA SISTEMA DE ENFRIAMIENTO

No. de Parte AHE	Código de Fabricación Gates	No. De Parte Gates	Grados	D.I.	LA	LB	Longitud	Capas
AHP4533400-3BL	773477344000	SIH400063C45	45	4"	3"	3"	9.5"	3
AHP4533200-3BL	773477344001	SIH300064D45	45	2"	3"	3"	9"	4
AHP4543400-6BL	773477344002	SIH400124C45	45	4"	6"	6"	16"	4
AHP4543400-3BL	773477344003	SIH4001245C45	45	4"	6"	6"	16.5"	4
AHP4553400-3BL	773477344004	SIH400065C45	45	4"	3"	3"	9.5"	5
AHP9033175-6BL	773477344005	SIH175123C90	90	1 3/4"	6"	6"	13.5"	3
AHP9033275-6BL	773477344006	SIH275123C90	90	2 3/4"	6"	6"	13.5"	3
AHP9033350-6BL	773477344007	SIH350123C90	90	3 1/2"	6"	6"	13.5"	3
AHP9043200-6BL	773477344008	SIH200124C90	90	2"	6"	6"	13.5"	4
AHP9043225-6BL	773477344009	SIH225124C90	90	2 1/4"	6"	6"	13.5"	4
AHP9043250-6BL	773477344010	SIH250124C90	90	2 1/2"	6"	6"	13.5"	4
AHP9043275-6BL	773477344011	SIH275124C90	90	2 3/4"	6"	6"	13.5"	4
AHP9043300-6BL	773477344012	SIH300084C90	90	3"	6"	6"	13.5"	4
AHP9043300-6BL	773477344013	SIH300124C90	90	3"	6"	6"	13.5"	4
AHP9043350-6BL	773477344014	SIH350124C90	90	3 1/2"	6"	6"	13.5"	4
AHP9043400-6BL	773477344015	SIH400124C90	90	4"	6"	6"	13.5"	4
AHP9053200-6BL	773477344016	SIH200125C90	90	2"	6"	6"	13.5"	5
AHP9053225-6BL	773477344017	SIH225125C90	90	2 1/4"	6"	6"	13.5"	5
AHP9053250-6BL	773477344018	SIH250125C90	90	2 1/2"	6"	6"	13.5"	5
AHP9053300-6BL	773477344019	SIH300125C90	90	3"	6"	6"	13.5"	5
AHP9053400-6BL	773477344020	SIH400125C90	90	4"	6"	6"	13.5"	5
AHP9053400-7BL	773477344021	SIH400145C90	90	4"	7"	7"	16.5"	5



MANGUERA DE CALEFACCIÓN

No. de Parte AHE	Código de Fabricación Gates	No. De Parte Gates	D.I.	Longitud
AHH250-25	82300038	26238	1/4"	7.26 metros
AHH375-25	82300039	26239	3/8"	7.26 metros
AHH500-25	82300040	26240	1/2"	7.26 metros
AHH625-25	82300041	26241	5/8"	7.26 metros
AHH750-25	82300042	26242	3/4"	7.26 metros
AHH875-25	82300043	26243	7/8"	7.26 metros
AHH1000-25	82300044	26244	1"	7.26 metros



MANGUERA RECTA PARA TURBOCOMPRESOR

No. de Parte AHE	No. De Parte Gates	D.I.	Longitud
C036100-36	26116	1"	36"
C036150-36	26124	1 1/2"	36"
C036175-36	26128	1 3/4"	36"
C036200-36	26132	2"	36"
C036225-36	26136	2 1/4"	36"
C036238-36	26138	2 3/8"	36"
C036250-36	26140	2 1/2"	36"
C036263-36	26148	2 5/8"	36"
C036275-36	26144	2 3/4"	36"
C036300-36	26148	3"	36"
C036338-36	26154	3 3/8"	36"
C036350-36	26156	3 1/2"	36"
C036375-36	26160	3 3/4"	36"
C036400-36	26164	4"	36"
C036450-36	26166	4 1/2"	36"

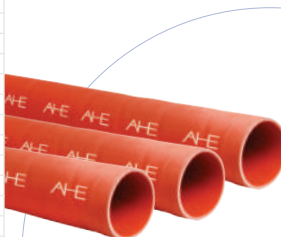

MANGUERA RECTA PARA RADIADOR

No. de Parte AHE	No. De Parte Gates	D.I.	Longitud
AHP33050-36BL	24808	1/2"	36"
AHP33062-36BL	24810	5/8"	36"
AHP33075-36BL	24812	3/4"	36"
AHP33087-36BL	24814	7/8"	36"
AHP33100-36BL	24816	1"	36"
AHP33113-36BL	24818	1 1/8"	36"
AHP33125-36BL	24820	1 1/4"	36"
AHP33138-36BL	24822	1 3/8"	36"
AHP33150-36BL	24824	1 1/2"	36"
AHP33163-36BL	24826	1 5/8"	36"
AHP33175-36BL	24828	1 3/4"	36"
AHP33225-36BL	24836	2 1/4"	36"
AHP33238-36BL	24838	2 3/8"	36"
AHP33250-36BL	24840	2 1/2"	36"
AHP33275-36BL	24844	2 3/4"	36"
AHP33300-36BL	24848	3"	36"
AHP33312-36BL	24850	3 1/8"	36"
AHP33325-36BL	24852	3 1/4"	36"
AHP33350-36BL	24856	3 1/2"	36"
AHP33375-36BL	24860	3 3/4"	36"
AHP33400-36BL	24864	4"	36"
AHP33450-36BL	24872	4 1/2"	36"
AHP33075-36BL	SIH075363C	3/4"	36"
AHP33100-36BL	SIH100363C	1"	36"
AHP33125-36BL	SIH125363C	1 1/4"	36"
AHP33150-36BL	SIH150363C	1 1/2"	36"
AHP33175-36BL	SIH175363C	1 3/4"	36"
AHP33200-36BL	SIH200363C	2"	36"
AHP33250-36BL	SIH250363C	2 1/2"	36"
AHP33300-36BL	SIH300363C	3"	36"
AHP33400-36BL	SIH400363C	4"	36"
AHP33275-36BL	SIH275363C	2 3/4"	36"



APLICA APLICACIONES CIONES

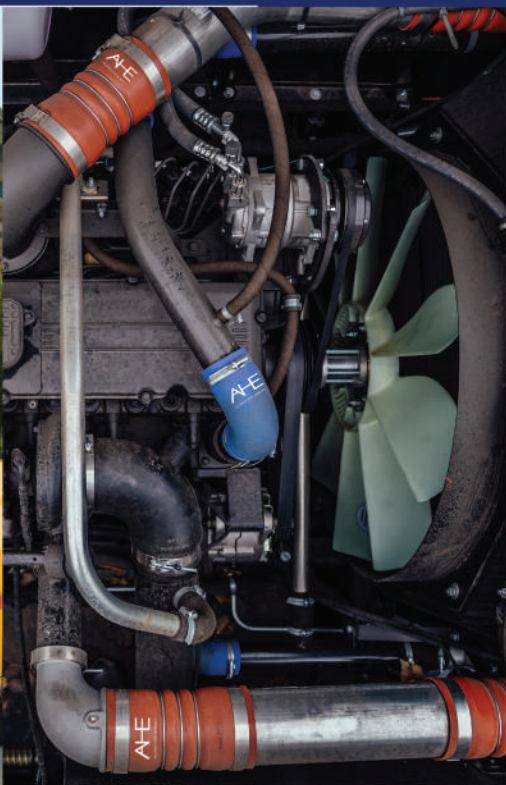

MARCA	MODELO	MOTOR	NÚMEROS DE PARTE AHE
DINA	DINA LINNER 2015	*****	C3M46102-152R, AHP4543300-6BL, AHH375
DINA	DINA 2015	*****	AHP33125-36BL TRAMO DE 4" , AHP4543300-6BL, AHP33300-36BL TRAMO DE 8"
FORD	F-600	CUMMINS B SERIES 5.9 L DIESEL	AHP33200-36BL
FORD	F-600	CUMMINS C SERIES 8.3 L DIESEL	AHP33200-36BL
FORD	F-600	FORD 6 CIL, 6.6 L DIESEL	AHP33250-36BL
FORD	F-650 SUPER DUTY	CATERPILLAR C7 DIESEL	AHP33200-36BL
FORD	F-650 SUPER DUTY	FORD V8, 7.3 L DIESEL	AHP33200-36BL
FORD	F-750 SUPER DUTY	CATERPILLAR 3126 DIESEL	AHP33200-36BL
FORD	F-750 SUPER DUTY	FORD V8, 7.3 L DIESEL	AHP33200-36BL
FORD	F-600	FORD 6 CIL, 7.8 L DIESEL	AHP33250-36BL
FORD	F-650 SUPER DUTY	CATERPILLAR 3126 DIESEL	AHP33200-36BL
FORD	F-650 SUPER DUTY	CUMMINS ISB DIESEL	AHP33200-36BL
FORD	F-750 SUPER DUTY	CATERPILLAR C7 DIESEL	AHP33200-36BL
FORD	F-750 SUPER DUTY	CUMMINS ISB DIESEL	AHP33200-36BL
FOTON AUV	2015	*****	C3M464102-203R, AHP9043200-6BL, AHP9056300-6BL
FREIGHTLINER	ARGOSY	DETROIT DIESEL 6 CIL, 11.1 L DIESEL	AHP33275-36BL, AHP33250-36BL
FREIGHTLINER	ARGOSY	DETROIT DIESEL 6 CIL, 12.7 L DIESEL	AHP33275-36BL, AHP33250-36BL
FREIGHTLINER	ARGOSY	DETROIT DIESEL 6 CIL, 14.0 L DIESEL	AHP33275-36BL, AHP33250-36BL
FREIGHTLINER	FL 360	MITSUBISHI 4M50-3A	AHP33250-36BL
FREIGHTLINER	CL 120	CATERPILLAR C13	AHP33250-36BL
FREIGHTLINER	CL 120	CUMMINS ISM	C3M46102-152R
FREIGHTLINER	FL 106	DETROIT DIESEL SERIE 50	AHP33250-36BL
FREIGHTLINER	FL 112 REV	CATERPILLAR C12	AHP33250-36BL
FREIGHTLINER	FL 112 REV	CATERPILLAR C10	AHP33250-36BL
FREIGHTLINER	FL 112 REV	CATERPILLAR 3176B	AHP33250-36BL
FREIGHTLINER	FL 112 REV	CUMMINS M11	AHP33250-36BL
FREIGHTLINER	FL 112	CUMMINS ISM DIESEL	AHP33250-36BL
FREIGHTLINER	FLB	CUMMINS N14 DIESEL	AHH1000
FREIGHTLINER	FLC	CATERPILLAR 3176 DIESEL	AHP33200-36BL, AHP33250-36BL
FREIGHTLINER	FLC	CATERPILLAR 3306 DIESEL	AHP33250-36BL
FREIGHTLINER	FLC	CUMMINS N14 DIESEL	AHP33200-36BL, AHP33250-36BL, AHP33300-36BL
FREIGHTLINER	FLC	CUMMINS M11 DIESEL	AHP33250-36BL
FREIGHTLINER	FLC	DETROIT DIESEL 6 CIL, 11.1 L DIESEL	AHP33250-36BL, AHP33300-36BL
FREIGHTLINER	FLC	DETROIT DIESEL 6 CIL, 12.7 L DIESEL	AHP33250-36BL, AHP33300-36BL
FREIGHTLINER	FLD 120	CATERPILLAR 3176 DIESEL	AHP33200-36BL, AHP33250-36BL
FREIGHTLINER	FLD 120	CATERPILLAR 3306 DIESEL	AHP33250-36BL
FREIGHTLINER	FLD 120	CATERPILLAR 3406B	C3M46102-152R, AHP33250-36BL, AHP33300-36BL, AHH1000
FREIGHTLINER	FLD 120	CATERPILLAR 3406E	AHP33250-36BL, AHP33300-36BL, AHH1000
FREIGHTLINER	FLD 120	CATERPILLAR C10	AHP33250-36BL
FREIGHTLINER	FLD 120	CATERPILLAR C12	AHP33250-36BL
FREIGHTLINER	FLD 120	CATERPILLAR C13 DIESEL	AHP33250-36BL
FREIGHTLINER	FLD 120	CATERPILLAR C15	AHP33250-36BL, AHP33300-36BL
FREIGHTLINER	FLD 120	CATERPILLAR C16 DIESEL	AHP33250-36BL, AHP33300-36BL
FREIGHTLINER	FLD 120	CUMMINS M11 DIESEL	AHP33250-36BL
FREIGHTLINER	FLD 120	CUMMINS N14	AHP33200-36BL, AHP33300-36BL, AHP33250-36BL
FREIGHTLINER	FLD 120	CUMMINS ISM DIESEL	AHP33250-36BL
FREIGHTLINER	FLD 120	DETROIT DIESEL SERIE 60	AHP33250-36BL, AHP33300-36BL
FREIGHTLINER	FL 70	CUMMINS 6BT5.9	C346300-6R
FREIGHTLINER	FL 70	CUMMINS 8.3L	C346300-6R
FREIGHTLINER	FL 70	CUMMINS B5.9	C346300-6R
FREIGHTLINER	FL 70	CUMMINS ISB	C346300-6R
FREIGHTLINER	FL 70	CUMMINS ISC	C346300-6R
FREIGHTLINER	FL 70	CATERPILLAR 3126	C346300-6R
FREIGHTLINER	FL 70	MERCEDES BENZ MBE900	C3M3676-140R
FREIGHTLINER	FL 80	CUMMINS 6BT5.9	C346300-6R
FREIGHTLINER	FL 80	CUMMINS 6C8.3	C346300-6R
FREIGHTLINER	FL 80	CUMMINS 8.3L	C346300-6R
FREIGHTLINER	FL 80	CUMMINS B5.9	C346300-6R
FREIGHTLINER	FL 80	CUMMINS ISB	C346300-6R
FREIGHTLINER	FL 80	CUMMINS ISC	C346300-6R
FREIGHTLINER	FL 80	CATERPILLAR 3126	C346300-6R

MARCA	MODELO	MOTOR	NÚMEROS DE PARTE AHE
FREIGHTLINER	FL 80	MERCEDES BENZ MBE900	C3M3676-140R
FREIGHTLINER	FL 80	DETROIT DIESEL SERIE 50	C346300-6R
FREIGHTLINER	FL 80	DETROIT DIESEL SERIE 60	C3M46102-152R, C346300-6R
FREIGHTLINER	FL 60	CUMMINS 5.9L NATURAL GAS	C346350-6R
FREIGHTLINER	FL 60	CUMMINS B5.9	C346350-6R
FREIGHTLINER	FL 60	CUMMINS ISB	C346350-6R
FREIGHTLINER	FL 60	CUMMINS ISC	C346350-6R
FREIGHTLINER	FL 60	CATERPILLAR 3126	C346350-6R
FREIGHTLINER	FL 60	MERCEDES BENZ MBE900	C346350-6R
FREIGHTLINER	M2	CATERPILLAR 3126	AHP33200-36BL, AHP33250-36BL, C346300-6R
FREIGHTLINER	M2	CATERPILLAR C11	C346300-6R
FREIGHTLINER	M2	CATERPILLAR C12	C346300-6R
FREIGHTLINER	M2	CATERPILLAR C13	C346300-6R
FREIGHTLINER	M2	CATERPILLAR C15	C346300-6R
FREIGHTLINER	M2	CATERPILLAR C7	AHP33250-36BL, C346300-6R
FREIGHTLINER	M2	CUMMINS ISB	AHP33250-36BL, C346300-6R
FREIGHTLINER	M2	CUMMINS ISB-07	AHP33250-36BL, C346300-6R
FREIGHTLINER	M2	CUMMINS ISC	AHP33200-36BL, AHP33250-36BL, C346300-6R
FREIGHTLINER	M2	MERCEDES BENZ MBE900-1	C3M3676-140R
FREIGHTLINER	M2	MERCEDES BENZ MBE4000	C3M3676-140R
FREIGHTLINER	M2	MERCEDES BENZ MBE406	C3M3676-140R
FREIGHTLINER	M2	MERCEDES BENZ MBE900	AHP33200-36BL, AHP33250-36BL, C3M3676-140R
FREIGHTLINER	M2	MERCEDES BENZ MBE926/LA	C3M3676-140R
FREIGHTLINER	M2	MERCEDES BENZ OM 904 LA	C3M3676-140R
FREIGHTLINER	M2 112	CUMMINS ISL	C3M46102-152R
FREIGHTLINER	M2 112	DETROIT DIESEL DD13	C346300-6R
FREIGHTLINER	M2 112	DETROIT DIESEL DD15	C346300-6R
FREIGHTLINER	M2 25K	MERCEDES BENZ 924	C3M3676-140R
FREIGHTLINER	M2 35K	MERCEDES BENZ 906	C3M3676-140R
FREIGHTLINER	M3	MERCEDES BENZ MBE 900 DIESEL	AHP33200-36BL
FREIGHTLINER	CENTURY CLASS	CATERPILLAR C13 DIESEL	AHP33250-36BL, AHH625, AHH750, AHH1000
FREIGHTLINER	CENTURY CLASS	DETROIT DIESEL 6 CIL, 12.7 L	AHP33250-36BL, AHP33300-36BL, AHH625, AHH750, AHH1000
FREIGHTLINER	COLUMBIA	CUMMINS ISX	C3M46102-152R, AHP33250-36BL, AHH625, AHH750, AHH1000
FREIGHTLINER	COLUMBIA	DETROIT DIESEL SERIE 60	C3M46102-152R, AHP33250-36BL, AHH625, AHH750, AHH1000
FREIGHTLINER	COLUMBIA	CATERPILLAR C15 DIESEL	AHP33250-36BL, AHH625, AHH750, AHH1000
FREIGHTLINER	COLUMBIA	CATERPILLAR C16 DIESEL	AHP33250-36BL, AHH625, AHH750, AHH1000
FREIGHTLINER	CASCADIA	CATERPILLAR 3406B	C3M46102-152R
FREIGHTLINER	CASCADIA	CATERPILLAR 3406E	AHP33250-36BL
FREIGHTLINER	CASCADIA	CATERPILLAR C10	AHP33250-36BL
FREIGHTLINER	CASCADIA	CATERPILLAR C12	AHP33250-36BL
FREIGHTLINER	CASCADIA	CATERPILLAR C15	AHP33250-36BL
FREIGHTLINER	CASCADIA	DETROIT DIESEL DD15	AHP33250-36BL
FREIGHTLINER	CASCADIA	DETROIT DIESEL DD13	AHP33250-36BL
FREIGHTLINER	CASCADIA	DETROIT DIESEL SERIE 60	C3M46102-152R, AHP33250-36BL
FREIGHTLINER	CASCADIA	CUMMINS ISX	C3M46102-152R
FREIGHTLINER	CLASSIC XL	DETROIT DIESEL 6 CIL, 11.1 L	AHP33250-36BL, AHP33300-36BL
FREIGHTLINER	CLASSIC XL	DETROIT DIESEL 6 CIL, 12.7 L	AHP33250-36BL, AHP33300-36BL
FREIGHTLINER	CLASSIC XL	CATERPILLAR C16 DIESEL	AHP33250-36BL, AHP33300-36BL
FREIGHTLINER	CLASSIC XL	CUMMINS N14 DIESEL	AHP33250-36BL, AHP33300-36BL
FREIGHTLINER	CORONADO	DETROIT DIESEL 6 CIL, 14.0 L	AHP33250-36BL
FREIGHTLINER	114SD	CUMMINS ISL	C346300-6R, AHP33250-36BL
FREIGHTLINER	ARGOSY	CATERPILLAR 3406 DIESEL	AHP33250-36BL
FREIGHTLINER	ARGOSY	CATERPILLAR C15 DIESEL	AHP33250-36BL
FREIGHTLINER	ARGOSY	CUMMINS ISM DIESEL	AHP33250-36BL
FREIGHTLINER	FL 112	DETROIT DIESEL SERIES 55	AHP33250-36BL
FREIGHTLINER	FL 112	MERCEDES BENZ MBE 4000	AHP33250-36BL
FREIGHTLINER	FLC	CUMMINS L10 DIESEL	AHP33250-36BL
FREIGHTLINER	FLD 120	CATERPILLAR C11 DIESEL	AHP33250-36BL
FREIGHTLINER	FLD 120	CUMMINS ISX DIESEL	AHP33250-36BL
FREIGHTLINER	FLD 120	CUMMINS L10 DIESEL	AHP33250-36BL
FREIGHTLINER	CENTURY CLASS	CATERPILLAR C11 DIESEL	AHP33250-36BL, AHH625, AHH750, AHH1000

MARCA	MODELO	MOTOR	NÚMEROS DE PARTE AHE
FREIGHTLINER	CENTURY CLASS	CATERPILLAR C15 DIESEL	AHP33250-36BL, AHP33300-36BL, AHH625, AHH750, AHH1000
FREIGHTLINER	CENTURY CLASS	DETROIT DIESEL SERIES 55	AHP33250-36BL, AHH625, AHH750, AHH1000
FREIGHTLINER	CENTURY CLASS	DETROIT DIESEL 6 CIL, 11.1 L	AHP33250-36BL, AHP33300-36BL, AHH625, AHH750, AHH1000
FREIGHTLINER	CENTURY CLASS	DETROIT DIESEL 6 CIL, 14.0 L	AHP33250-36BL, AHH625, AHH750, AHH1000
FREIGHTLINER	CENTURY CLASS	CATERPILLAR 3406 DIESEL	AHP33250-36BL, AHP33300-36BL, AHH625, AHH750, AHH1000
FREIGHTLINER	CENTURY CLASS	CUMMINS M11 DIESEL	AHP33250-36BL, AHH625, AHH750, AHH1000
FREIGHTLINER	CENTURY CLASS	CUMMINS ISM DIESEL	AHP33250-36BL, AHH625, AHH750, AHH1000
FREIGHTLINER	CENTURY CLASS	CUMMINS ISX DIESEL	AHP33250-36BL, AHH625, AHH750, AHH1000
FREIGHTLINER	CENTURY CLASS	CUMMINS N14 DIESEL	AHP33250-36BL, AHH625, AHH750, AHH1000
FREIGHTLINER	CENTURY CLASS	MERCEDES BENZ MBE 4000	AHP33250-36BL, AHH625, AHH750, AHH1000
FREIGHTLINER	COLUMBIA	CUMMINS ISM DIESEL	AHP33250-36BL, AHH625, AHH750, AHH1000
FREIGHTLINER	COLUMBIA	CUMMINS N14 DIESEL	AHP33250-36BL, AHH625, AHH750, AHH1000
FREIGHTLINER	COLUMBIA	CATERPILLAR C10 DIESEL	AHP33250-36BL, AHH625, AHH750, AHH1000
FREIGHTLINER	COLUMBIA	CATERPILLAR C13 DIESEL	AHP33250-36BL, AHH625, AHH750, AHH1000
FREIGHTLINER	COLUMBIA	CATERPILLAR C12 DIESEL	AHP33250-36BL, AHH625, AHH750, AHH1000
FREIGHTLINER	COLUMBIA	CATERPILLAR C11 DIESEL	AHP33250-36BL, AHH625, AHH750, AHH1000
FREIGHTLINER	COLUMBIA	CATERPILLAR C16 DIESEL	AHP33250-36BL, AHH625, AHH750, AHH1000
FREIGHTLINER	COLUMBIA	MERCEDES BENZ MBE 4000 DIESEL	AHP33250-36BL, AHH625, AHH750, AHH1000
FREIGHTLINER	CLASSIC	CUMMINS ISM DIESEL	AHP33250-36BL
FREIGHTLINER	CLASSIC	DETROIT DIESEL 6 CIL, 11.1 L	AHP33250-36BL, AHP33300-36BL
FREIGHTLINER	CLASSIC	DETROIT DIESEL 6 CIL, 14.0 L	AHP33250-36BL
FREIGHTLINER	CLASSIC	DETROIT DIESEL 6 CIL, 12.7 L	AHP33250-36BL, AHP33300-36BL
FREIGHTLINER	CLASSIC	CATERPILLAR C15 DIESEL	AHP33250-36BL, AHP33300-36BL
FREIGHTLINER	CLASSIC	CATERPILLAR C16 DIESEL	AHP33250-36BL, AHP33300-36BL
FREIGHTLINER	CLASSIC	CUMMINS N14 DIESEL	AHP33250-36BL, AHP33300-36BL
FREIGHTLINER	CLASSIC XL	CUMMINS ISM DIESEL	AHP33250-36BL
FREIGHTLINER	CLASSIC XL	DETROIT DIESEL 6 CIL, 14.0 L	AHP33250-36BL, AHP33300-36BL
FREIGHTLINER	CLASSIC XL	CATERPILLAR C15 DIESEL	AHP33250-36BL, AHP33300-36BL
FREIGHTLINER	CORONADO	CATERPILLAR C15 DIESEL	AHP33250-36BL
FREIGHTLINER	CORONADO	DETROIT DIESEL 6 CIL, 12.7 L	AHP33250-36BL
INTERNATIONAL	WORKSTAR	CUMMINS ISM 10.8 LTS 6 CIL	C3M46102-152R, C346300-6R
INTERNATIONAL	7300	NAVISTAR DT466	AHP33250-36BL, C346300-6R
INTERNATIONAL	7400 WORKSTAR	NAVISTAR DT466	AHP33250-36BL
INTERNATIONAL	7400 WORKSTAR	NAVISTAR MAXXFORCE 9 DIESEL	AHP33250-36BL
INTERNATIONAL	7400	NAVISTAR 530	AHP33275-36BL
INTERNATIONAL	7400	NAVISTAR 570 DIESEL	AHP33250-36BL
INTERNATIONAL	7400	NAVISTAR DT570 DIESEL	AHP33250-36BL, C346300-6R
INTERNATIONAL	7400	CUMMINS ISM DIESEL	AHP33250-36BL, C3M46102-152R
INTERNATIONAL	7400	NAVISTAR DT530 DIESEL	AHP33250-36BL
INTERNATIONAL	7500	NAVISTAR HT570	AHP33275-36BL, AHP33250-36BL
INTERNATIONAL	7500	NAVISTAR 530	AHP33275-36BL
INTERNATIONAL	7500	NAVISTAR DT466	AHP33250-36BL
INTERNATIONAL	7500	NAVISTAR DT530 DIESEL	AHP33250-36BL
INTERNATIONAL	7600	CATERPILLAR C10 DIESEL	AHP33250-36BL
INTERNATIONAL	7600	CATERPILLAR C12 DIESEL	AHP33250-36BL
INTERNATIONAL	7600 WORKSTAR	CATERPILLAR C11	AHP33250-36BL
INTERNATIONAL	7600 WORKSTAR	CATERPILLAR C13	AHP33250-36BL
INTERNATIONAL	7600 WORKSTAR	CUMMINS ISM	AHP33250-36BL, C3M46102-152R
INTERNATIONAL	7700	CATERPILLAR C13 DIESEL	AHP33250-36BL
INTERNATIONAL	7700	CUMMINS ISM DIESEL	AHP33250-36BL, C3M46102-152R
INTERNATIONAL	7700	CATERPILLAR C11 DIESEL	AHP33250-36BL
INTERNATIONAL	8100	CUMMINS ISM DIESEL	AHP33250-36BL, C3M46102-152R
INTERNATIONAL	8100	CUMMINS N14 DIESEL	AHP33250-36BL
INTERNATIONAL	8100	CUMMINS L10 DIESEL	AHP33250-36BL
INTERNATIONAL	8100	NAVISTAR DT466	AHP33250-36BL
INTERNATIONAL	8100	NAVISTAR 530 DIESEL	AHP33250-36BL
INTERNATIONAL	8100	CATERPILLAR 3176 DIESEL	AHP33250-36BL
INTERNATIONAL	8100	CUMMINS M11 DIESEL	AHP33250-36BL
INTERNATIONAL	8100	NAVISTAR 530 DIESEL	AHP33250-36BL
INTERNATIONAL	8100	CATERPILLAR C10 DIESEL	AHP33250-36BL
INTERNATIONAL	8200	CUMMINS ISM	AHP33250-36BL, C3M46102-152R

MARCA	MODELO	MOTOR	NÚMEROS DE PARTE AHE
INTERNATIONAL	8200	DETROIT DIESEL 6 CIL, 11.1 L	AHP33250-36BL
INTERNATIONAL	8200	CUMMINS N14 DIESEL	AHP33250-36BL
INTERNATIONAL	8200	DETROIT DIESEL 6 CIL, 12.7 L	AHP33250-36BL
INTERNATIONAL	8200	CUMMINS L10 DIESEL	AHP33250-36BL
INTERNATIONAL	8200	NAVISTAR 530 DIESEL	AHP33250-36BL
INTERNATIONAL	8200	CUMMINS M11 DIESEL	AHP33250-36BL
INTERNATIONAL	8200	NAVISTAR DT466	AHP33250-36BL
INTERNATIONAL	8600	CATERPILLAR C13	AHH1000, AHP33250-36BL
INTERNATIONAL	8600	CATERPILLAR C10 DIESEL	AHP33250-36BL
INTERNATIONAL	8600	CATERPILLAR C11 DIESEL	AHP33250-36BL
INTERNATIONAL	8600	CUMMINS ISM DIESEL	AHP33250-36BL, C3M46102-152R
INTERNATIONAL	8600	CATERPILLAR C12 DIESEL	AHP33250-36BL
INTERNATIONAL	4300 DURASTAR	NAVISTAR DT466	AHH750, C346300-6R
INTERNATIONAL	4300 LP	MAXXFORCE DT 7.6 LT	AHH750,AHH1000, C346300-6R
INTERNATIONAL	4400 DURASTAR	NAVISTAR DT 530	C346300-6R
INTERNATIONAL	4400 DURASTAR	NAVISTAR MAXXFORCE 9	C346300-6R
INTERNATIONAL	4400 DURASTAR	NAVISTAR MAXXFORCE 10	C346300-6R
INTERNATIONAL	4400LP DURASTAR	NAVISTAR DT466HT	AHH750, C346300-6R
INTERNATIONAL	4400LP DURASTAR	NAVISTAR DT570	C346300-6R
INTERNATIONAL	4400LP DURASTAR	NAVISTAR MAXXFORCE 9	C346300-6R
INTERNATIONAL	4400LP DURASTAR	NAVISTAR MAXXFORCE 10	C346300-6R
INTERNATIONAL	DURASTAR	CUMMINS ISB 6.7 LTS 6 CIL	C346300-6R
INTERNATIONAL	DURASTAR	INTERNATIONAL DT-570 9 LTS 6 CIL	C346300-6R
INTERNATIONAL	DURASTAR	INTERNATIONAL DT-466 9 LTS 6 CIL	C346300-6R
INTERNATIONAL	LONESTAR	CUMMINS ISX 15 LTS 6 CIL	C3M46102-152R
INTERNATIONAL	PAYSTAR 5500I	CUMMINS ISX DIESEL	AHP33250-36BL, C3M46102-152R
INTERNATIONAL	PAYSTAR 5600I	CATERPILLAR C15 DIESEL	AHP33300-36BL
INTERNATIONAL	PAYSTAR 5900I	CUMMINS ISX DIESEL	AHP33250-36BL, C3M46102-152R
INTERNATIONAL	PROSTAR	CUMMINS ISX 15 LTS 6 CIL	AHH750, AHP33250-36BL, C3M46102-152R
INTERNATIONAL	PROSTAR	CATERPILLAR C13	C346300-6R
INTERNATIONAL	PROSTAR	NAVISTAR MAXXFORCE 11	C346300-6R
INTERNATIONAL	PROSTAR	NAVISTAR MAXXFORCE 13	AHP33250-36BL
INTERNATIONAL	PROSTAR	NAVISTAR MAXXFORCE 15	C346300-6R
INTERNATIONAL	PROSTAR	NAVISTAR DT466	C346300-6R
INTERNATIONAL	PROSTAR	NAVISTAR MAXXFORCE 4.8/7.2	C346300-6R
INTERNATIONAL	TRANSTAR	CUMMINS ISM 10.8 LTS 6 CIL	C3M46102-152R
INTERNATIONAL	3000 RE	NAVISTAR 7.3L	C2M4664/89X3-146RM
INTERNATIONAL	3000 RE	NAVISTAR VT-365	C346300-6R
INTERNATIONAL	3000 RE	MWM 7.2 LTS 6 CIL.	C2M4664/89X3-146RM, AHP33200-36BL, AHP4543300-6BL
INTERNATIONAL	3300 CE	NAVISTAR MAXXFORCE DT	C346300-6R, C346350-6R
INTERNATIONAL	3800	NAVISTAR T444	AHP33300-36BL, C346350-6R
INTERNATIONAL	4700	NAVISTAR DT360	C346300-6R
INTERNATIONAL	4900	DETROIT DIESEL SERIE 60	C3M46102-152R
INTERNATIONAL	4900	NAVISTAR DT466	C2M4664/89X3-146RM
INTERNATIONAL	4700 LP	NAVISTAR DT360	C346300-6R
INTERNATIONAL	5000	CUMMINS M11 DIESEL	AHP33250-36BL
INTERNATIONAL	5000	INTERNATIONAL/NAVISTAR 530 DIESEL	AHP33250-36BL
INTERNATIONAL	5000	CUMMINS ISM DIESEL	AHP33250-36BL, C3M46102-152R
INTERNATIONAL	5000	CUMMINS L10 DIESEL	AHP33250-36BL
INTERNATIONAL	5000	CUMMINS N14 DIESEL	AHP33250-36BL
INTERNATIONAL	5500I	CATERPILLAR C13 DIESEL	AHP33250-36BL, AHH250, AHH750, AHH1000
INTERNATIONAL	5500I	CUMMINS ISM DIESEL	AHP33250-36BL, C3M46102-152R, AHH250, AHH750, AHH1000
INTERNATIONAL	5500I	CUMMINS N14 DIESEL	AHP33250-36BL, AHH250, AHH750, AHH1000
INTERNATIONAL	5500I	CATERPILLAR C10 DIESEL	AHP33250-36BL, AHH250, AHH750, AHH1000
INTERNATIONAL	5500I	CUMMINS ISM DIESEL	AHP33250-36BL, C3M46102-152R, AHH250, AHH750, AHH1000
INTERNATIONAL	5500I	CUMMINS ISX DIESEL	AHP33250-36BL, C3M46102-152R, AHH250, AHH750, AHH1000
INTERNATIONAL	5500I	CATERPILLAR C12 DIESEL	AHP33250-36BL, AHH250, AHH750, AHH1000
INTERNATIONAL	5600I	CATERPILLAR C12 DIESEL	AHP33250-36BL, AHH250, AHH750, AHH1000
INTERNATIONAL	5600I	CATERPILLAR C13 DIESEL	AHP33250-36BL, AHH250, AHH750, AHH1000
INTERNATIONAL	5600I	CUMMINS ISM DIESEL	AHP33250-36BL, C3M46102-152R, AHH250, AHH750, AHH1000

MARCA	MODELO	MOTOR	NÚMEROS DE PARTE AHE
INTERNATIONAL	5600I	CUMMINS ISX DIESEL	AHP33250-36BL, C3M46102-152R, AHH250, AHH750, AHH1000
INTERNATIONAL	5600I	CATERPILLAR C10 DIESEL	AHP33250-36BL, AHH250, AHH750, AHH1000
INTERNATIONAL	5600I	CUMMINS N14 DIESEL	AHP33250-36BL, AHH250, AHH750, AHH1000
INTERNATIONAL	5900I	CATERPILLAR C10 DIESEL	AHP33250-36BL
INTERNATIONAL	5900I	CUMMINS ISX DIESEL	AHP33250-36BL, C3M46102-152R
INTERNATIONAL	5900I	CATERPILLAR C12 DIESEL	AHP33250-36BL
INTERNATIONAL	5900I	CUMMINS ISM DIESEL	AHP33250-36BL, C3M46102-152R
INTERNATIONAL	5900I	CATERPILLAR C10 DIESEL	AHP33250-36BL
INTERNATIONAL	5900I	CUMMINS N14 DIESEL	AHP33250-36BL
INTERNATIONAL	5900I	CATERPILLAR C15 DIESEL	AHP33300-36BL
INTERNATIONAL	9100	CATERPILLAR 3406	AHP33300-36BL, AHP33250-36BL
INTERNATIONAL	9100	CUMMINS N14 DIESEL	AHP33250-36BL
INTERNATIONAL	9100	DETROIT DIESEL SERIE 60	AHP33250-36BL
INTERNATIONAL	9100	CATERPILLAR C10 DIESEL	AHP33250-36BL
INTERNATIONAL	9100	CATERPILLAR C12 DIESEL	AHP33250-36BL
INTERNATIONAL	9100I	CATERPILLAR C10 DIESEL	AHP33250-36BL
INTERNATIONAL	9100I	DETROIT DIESEL 6 CIL, 12.7 L	AHP33250-36BL
INTERNATIONAL	9100I	CUMMINS N14 DIESEL	AHP33250-36BL
INTERNATIONAL	9100I	CUMMINS ISM DIESEL	AHP33250-36BL, C3M46102-152R
INTERNATIONAL	9100I	DETROIT DIESEL SERIE 60	AHP33250-36BL
INTERNATIONAL	9100I	CATERPILLAR C12 DIESEL	AHP33250-36BL
INTERNATIONAL	9200	CUMMINS ISX	C3M46102-152R
INTERNATIONAL	9200	CATERPILLAR 3176	AHP33200-36BL, AHP33250-36BL
INTERNATIONAL	9200	CATERPILLAR 3406	AHP33300-36BL, AHP33250-36BL
INTERNATIONAL	9200	CUMMINS N14 DIESEL	AHP33250-36BL
INTERNATIONAL	9200	DETROIT DIESEL SERIE 60	AHP33250-36BL
INTERNATIONAL	9200	CUMMINS M11 DIESEL	AHP33250-36BL
INTERNATIONAL	9200	CATERPILLAR C10 DIESEL	AHP33250-36BL
INTERNATIONAL	9200	CATERPILLAR C12 DIESEL	AHP33250-36BL
INTERNATIONAL	9200I	CATERPILLAR C10	AHP33250-36BL, AHH250, AHH750, AHH1000
INTERNATIONAL	9200I	CATERPILLAR C11	AHP33250-36BL, AHH250, AHH750, AHH1000
INTERNATIONAL	9200I	CATERPILLAR C12	AHP33250-36BL, AHH250, AHH750, AHH1000
INTERNATIONAL	9200I	CATERPILLAR C13	AHP33250-36BL, AHH250, AHH750, AHH1000
INTERNATIONAL	9200I	CATERPILLAR C15	AHP33250-36BL, AHH250, AHH750, AHH1000
INTERNATIONAL	9200I	CUMMINS ISM	AHP33250-36BL, C3M46102-152R, AHH250, AHH750, AHH1000
INTERNATIONAL	9200I	CUMMINS ISX	AHP33250-36BL, C3M46102-152R, AHH250, AHH750, AHH1000
INTERNATIONAL	9200I	CUMMINS N14	AHP33250-36BL, AHH250, AHH750, AHH1000
INTERNATIONAL	9200I	DETROIT DIESEL SERIE 60	AHP33250-36BL, C3M46102-152R, AHH250, AHH750, AHH1000
INTERNATIONAL	9200I	CATERPILLAR C16 DIESEL	AHP33250-36BL, AHH250, AHH750, AHH1000
INTERNATIONAL	9200I	DETROIT DIESEL 6 CIL, 12.7 L	AHP33250-36BL, AHH250, AHH750, AHH1000
INTERNATIONAL	9300	CATERPILLAR 3406 DIESEL	AHP33300-36BL, AHP33250-36BL
INTERNATIONAL	9300	CATERPILLAR 3176	AHP33200-36BL, AHP33250-36BL
INTERNATIONAL	9300	CATERPILLAR C10 DIESEL	AHP33250-36BL
INTERNATIONAL	9300	DETROIT DIESEL 6 CIL, 11.1 L DIESEL	AHP33250-36BL
INTERNATIONAL	9300	CATERPILLAR 3406 DIESEL	AHP33250-36BL
INTERNATIONAL	9300	CUMMINS N14 DIESEL	AHP33250-36BL
INTERNATIONAL	9300	DETROIT DIESEL 6 CIL, 12.7 L	AHP33250-36BL
INTERNATIONAL	9300	DETROIT DIESEL SERIE 60	AHP33250-36BL
INTERNATIONAL	9300	CUMMINS M11 DIESEL	AHP33250-36BL
INTERNATIONAL	9300	CATERPILLAR C12 DIESEL	AHP33250-36BL
INTERNATIONAL	9400	CATERPILLAR 3176	AHP33200-36BL, AHP33250-36BL
INTERNATIONAL	9400	CUMMINS 855	AHP33250-36BL
INTERNATIONAL	9400	CUMMINS N14	AHP33250-36BL
INTERNATIONAL	9400	CATERPILLAR C10 DIESEL	AHP33250-36BL
INTERNATIONAL	9400	CUMMINS M11 DIESEL	AHP33250-36BL
INTERNATIONAL	9400	DETROIT DIESEL 6 CIL, 11.1 L	AHP33250-36BL
INTERNATIONAL	9400	DETROIT DIESEL 6 CIL, 12.7 L	AHP33250-36BL
INTERNATIONAL	9400	DETROIT DIESEL 6 CIL, 12.7 L	AHP33250-36BL
INTERNATIONAL	9400	CATERPILLAR C12 DIESEL	AHP33250-36BL
INTERNATIONAL	9400	DETROIT DIESEL SERIE 60	AHP33250-36BL

MARCA	MODELO	MOTOR	NÚMEROS DE PARTE AHE
INTERNATIONAL	9400	CATERPILLAR 3406	AHP33300-36BL, AHP33250-36BL
INTERNATIONAL	9400I	CATERPILLAR C15 DIESEL	AHP33300-36BL, AHP33250-36BL
INTERNATIONAL	9400I	CATERPILLAR C12 DIESEL	AHP33250-36BL
INTERNATIONAL	9400I	CATERPILLAR C16 DIESEL	AHP33250-36BL
INTERNATIONAL	9400I	CATERPILLAR 3406 DIESEL	AHP33250-36BL
INTERNATIONAL	9400I	CUMMINS ISM DIESEL	AHP33250-36BL, C3M46102-152R
INTERNATIONAL	9400I	DETROIT DIESEL SERIE 60	AHP33250-36BL
INTERNATIONAL	9400I	CATERPILLAR C10 DIESEL	AHP33250-36BL
INTERNATIONAL	9400I	CUMMINS N14 DIESEL	AHP33250-36BL
INTERNATIONAL	9400I	DETROIT DIESEL 6 CIL, 12.7 L	AHP33250-36BL
INTERNATIONAL	9400I	CUMMINS ISX	AHP33250-36BL, C3M46102-152R
INTERNATIONAL	9600	CUMMINS N14 DIESEL	AHP33250-36BL
INTERNATIONAL	9600	DETROIT DIESEL 6 CIL, 12.7 L	AHP33250-36BL
INTERNATIONAL	9600	DETROIT DIESEL 6 CIL, 11.1 L	AHP33250-36BL
INTERNATIONAL	9600	CUMMINS M11 DIESEL	AHP33250-36BL
INTERNATIONAL	9600	CATERPILLAR C10 DIESEL	AHP33250-36BL
INTERNATIONAL	9700	CUMMINS N14 DIESEL	AHP33250-36BL
INTERNATIONAL	9700	DETROIT DIESEL 6 CIL, 11.1 L	AHP33250-36BL
INTERNATIONAL	9700	DETROIT DIESEL 6 CIL, 12.7 L	AHP33250-36BL
INTERNATIONAL	9700	CUMMINS M11 DIESEL	AHP33250-36BL
INTERNATIONAL	9800	CUMMINS M11 DIESEL	AHP33250-36BL
INTERNATIONAL	9800	CUMMINS N14 DIESEL	AHP33250-36BL
INTERNATIONAL	9800	DETROIT DIESEL SERIE 60	AHP33250-36BL
INTERNATIONAL	9900	CATERPILLAR C12 DIESEL	AHP33250-36BL
INTERNATIONAL	9900	DETROIT DIESEL SERIE 60	AHP33250-36BL
INTERNATIONAL	9900	CATERPILLAR 3406 DIESEL	AHP33250-36BL
INTERNATIONAL	9900	CUMMINS N14 DIESEL	AHP33250-36BL
INTERNATIONAL	9900I	CATERPILLAR C15 DIESEL	AHP33300-36BL, AHP33250-36BL, AHH250, AHH750, AHH1000
INTERNATIONAL	9900I	CUMMINS ISX DIESEL	AHP33250-36BL, C3M46102-152R, AHH250, AHH750, AHH1000
INTERNATIONAL	9900I	DETROIT DIESEL SERIE 60	AHP33250-36BL, AHH250, AHH750, AHH1000
INTERNATIONAL	9900I	CATERPILLAR C16 DIESEL	AHP33250-36BL, AHH250, AHH750, AHH1000
INTERNATIONAL	9900I	CATERPILLAR C10 DIESEL	AHP33250-36BL, AHH250, AHH750, AHH1000
INTERNATIONAL	9900I	CUMMINS N14 DIESEL	AHP33250-36BL, AHH250, AHH750, AHH1000
INTERNATIONAL	9900I	DETROIT DIESEL 6 CIL, 12.7 L	AHP33250-36BL, AHH250, AHH750, AHH1000
INTERNATIONAL	9900I	CATERPILLAR 3406 DIESEL	AHP33250-36BL, AHH250, AHH750, AHH1000
INTERNATIONAL	9900I	CUMMINS ISM DIESEL	AHP33250-36BL, C3M46102-152R, AHH250, AHH750, AHH1000
INTERNATIONAL	9900I	CATERPILLAR C12 DIESEL	AHP33250-36BL, AHH250, AHH750, AHH1000
INTERNATIONAL	9900IX	CATERPILLAR C15 DIESEL	AHP33300-36BL, AHP33250-36BL
INTERNATIONAL	9900IX	CATERPILLAR 3406 DIESEL	AHP33250-36BL
INTERNATIONAL	9900IX	CUMMINS ISM DIESEL	AHP33250-36BL, C3M46102-152R
INTERNATIONAL	9900IX	CATERPILLAR C10 DIESEL	AHP33250-36BL
INTERNATIONAL	9900IX	CUMMINS ISX DIESEL	AHP33250-36BL, C3M46102-152R
INTERNATIONAL	9900IX	DETROIT DIESEL SERIE 60	AHP33250-36BL
INTERNATIONAL	9900IX	CATERPILLAR C12 DIESEL	AHP33250-36BL
INTERNATIONAL	9900IX	CATERPILLAR C16 DIESEL	AHP33250-36BL
INTERNATIONAL	9900IX	CUMMINS N14 DIESEL	AHP33250-36BL
INTERNATIONAL	9900IX	DETROIT DIESEL 6 CIL, 12.7 L	AHP33250-36BL
INTERNATIONAL	CXT	NAVISTAR DT466	AHP33250-36BL
INTERNATIONAL	INT 4700 FE	MWM 7.2 LTS 6 CIL.	AHP33200-36BL, C2M4664/89X3-146RM, AHP4543300-6BL
INTERNATIONAL	URBANSTAR	CUMMINS ISB 6.7 LTS 6 CIL	C346300-6R
INTERNATIONAL	URBANSTAR	MWM 7.2 LTS 6 CIL.	AHP33200-36BL, C2M4664/89X3-146RM, AHP4543300-6BL
INTERNATIONAL	URBANSTAR	MWM 4.8 LTS 4 CIL.	AHP33200-36BL, AHP4543300-6BL
KENWORTH	C500	CATERPILLAR C15	AHP33250-36BL, C3M46102-152R, AHP33200-36BL, AHP33300-36BL, C5M4664-216BLM
KENWORTH	C500	CATERPILLAR C16 DIESEL	AHP33250-36BL, AHP33200-36BL, AHP33300-36BL, C5M4664-216BLM
KENWORTH	C500	DETROIT DIESEL 6 CIL, 11.1 L	AHP33250-36BL, AHP33300-36BL, C5M4664-216BLM
KENWORTH	C500	DETROIT DIESEL 6 CIL, 12.7 L	AHP33250-36BL, AHP33300-36BL, C5M4664-216BLM
KENWORTH	KW 55	PACCAR DE 4 Y 6 CIL.	C346300-6R
KENWORTH	KW 45 12 TONS.	PACCAR PX-6	C346300-6R
KENWORTH	KW 55 15 TONS	PACCAR PX-6	C346300-6R

MARCA	MODELO	MOTOR	NÚMEROS DE PARTE AHE
KENWORTH	K100	CUMMINS C SERIES 8.3 L DIESEL	AHH1000, AHP33200-36BL
KENWORTH	K100	CATERPILLAR 3406 DIESEL	AHP33250-36BL, AHP33300-36BL
KENWORTH	K100	DETROIT DIESEL 6 CIL. 11.1 L DIESEL	AHP33250-36BL, AHP33300-36BL
KENWORTH	K100	CUMMINS N14 DIESEL	AHP33250-36BL, AHP33300-36BL
KENWORTH	K300	CUMMINS C SERIES 8.3 L DIESEL	AHP33200-36BL
KENWORTH	T460	CUMMINS ISL	C3M46102-152R
KENWORTH	T800	CUMMINS ISM	C3M46102-152R, C3M46102-203R, AHH250, C5M4664-216BLM
KENWORTH	T800	PACCAR MX-13	C3M46102-152R, C3M46102-203R, AHH250, C5M4664-216BLM
KENWORTH	T800	CUMMINS ISX	C3M46102-152R, C3M46102-203R, AHH250, C5M4664-216BLM
KENWORTH	T660	CUMMINS ISM	C3M46102-152R, C5M4664-216BLM
KENWORTH	T660	PACCAR MX-13	C3M46102-152R, C5M4664-216BLM
KENWORTH	T660	CUMMINS ISX	C3M46102-152R, C5M4664-216BLM
KENWORTH	T880 Y VOC.	CUMMINS ISM	C3M46102-152R, C5M4664-216BLM
KENWORTH	T880 Y VOC.	PACCAR MX-13	C3M46102-152R, C5M4664-216BLM
KENWORTH	T880 Y VOC.	CUMMINS ISX	C3M46102-152R, C5M4664-216BLM
KENWORTH	T680	CUMMINS ISM	C3M46102-152R, C5M4664-216BLM
KENWORTH	T680	PACCAR MX-13	C3M46102-152R, C5M4664-216BLM
KENWORTH	T680	CUMMINS ISX	C3M46102-152R, C5M4664-216BLM
KENWORTH	T2000	CATERPILLAR 3406E	AHP33250-36BL, AHP33300-36BL, AHH1000
KENWORTH	T2000	CATERPILLAR C10	AHP33250-36BL, AHP33300-36BL
KENWORTH	T2000	CATERPILLAR C11	AHH1000
KENWORTH	T2000	CATERPILLAR C12	AHP33250-36BL, AHP33300-36BL, AHH1000
KENWORTH	T2000	CATERPILLAR C13	C3M46102-152R, AHH1000
KENWORTH	T2000	CATERPILLAR C15	AHP33250-36BL, C3M46102-152R, AHH1000
KENWORTH	T2000	CUMMINS ISX	AHP33250-36BL, C3M46102-152R, AHH1000
KENWORTH	T2000	CUMMINS ISM	C3M46102-152R, AHH1000
KENWORTH	T2000	CUMMINS ISL	C3M46102-152R, AHH1000
KENWORTH	T2000	CUMMINS N12	AHH1000
KENWORTH	T2000	CUMMINS N14	AHP33250-36BL
KENWORTH	T2000	DETROIT DIESEL SERIE 60	C3M46102-152R, AHH1000
KENWORTH	T2000	DETROIT DIESEL 6 CIL. 12.7 L DIESEL	AHP33250-36BL
KENWORTH	T2000	DETROIT DIESEL 6 CIL. 11.1 L	AHP33250-36BL
KENWORTH	T270	PACCAR PX-6	C346300-6R, AHH1000
KENWORTH	T270	PACCAR PX9	C3M46102-203R, AHH1000
KENWORTH	T300	CATERPILLAR C7	AHH1000
KENWORTH	T300	CUMMINS 8.3L	AHH1000
KENWORTH	T300	CUMMINS ISB5.9L	AHH1000
KENWORTH	T300	CUMMINS ISC	AHP33250-36BL, AHH1000
KENWORTH	T300	CUMMINS ISM	C3M46102-152R, AHH1000
KENWORTH	T300	PACCAR PX-6	AHP33250-36BL, C346300-6R, AHH1000, AHP33175-36BL
KENWORTH	T300	PACCAR PX8	AHH1000
KENWORTH	T300	CATERPILLAR 3126	AHP33250-36BL, AHP33200-36BL, AHH1000
KENWORTH	T370	PACCAR PX-6	AHP33250-36BL, C346300-6R, AHP33175-36BL, AHP33200-36BL
KENWORTH	T370	PACCAR PX8	C3M46102-203R
KENWORTH	T370	PACCAR PX9	C3M46102-203R
KENWORTH	T400	CATERPILLAR 3176	AHP33250-36BL, AHP33200-36BL, AHH1000, AHP33300-36BL
KENWORTH	T400	CATERPILLAR 3306	AHP33250-36BL, AHH1000
KENWORTH	T400	CUMMINS FORMULA 10-240	AHH1000
KENWORTH	T400	CUMMINS L10	AHP33250-36BL, AHP33300-36BL, AHH1000
KENWORTH	T440	PACCAR PX-9	AHP4543250-3BL
KENWORTH	T440	CUMMINS ISL-G	AHP4543250-3BL
KENWORTH	T440	PACCAR PX-9	AHP4543250-3BL
KENWORTH	T440	PACCAR PX-8	AHP4543250-3BL
KENWORTH	T440	CUMMINS ISL	AHP4543250-3BL
KENWORTH	T450	PACCAR PX-6	AHP4543250-3BL, AHH1000
KENWORTH	T450	CATERPILLAR 3306 DIESEL	AHP33250-36BL
KENWORTH	T450	CATERPILLAR 3176 DIESEL	AHP33250-36BL, AHP33200-36BL, AHP33300-36BL
KENWORTH	T470	PACCAR PX-9	AHP4543250-3BL
KENWORTH	T470	PACCAR PX-8	AHP4543250-3BL
KENWORTH	T470	CUMMINS ISL	AHP4543250-3BL

MARCA	MODELO	MOTOR	NÚMEROS DE PARTE AHE
KENWORTH	T600	CATERPILLAR 3176	C3M46102-152R, AHP33250-36BL, AHP33200-36BL, AHP33300-36BL, C3M46102-203R, AHH250
KENWORTH	T600	CATERPILLAR 3306	C3M46102-152R, C3M46102-203R, AHH250
KENWORTH	T600	CATERPILLAR 3406T	AHP33250-36BL, AHP33300-36BL, C3M46102-152R, C3M46102-203R, AHH250
KENWORTH	T600	CATERPILLAR C10	AHP33250-36BL, AHP33300-36BL, C3M46102-152R, C3M46102-203R, AHH250
KENWORTH	T600	CATERPILLAR C12	AHP33250-36BL, AHP33300-36BL, C3M46102-152R, C3M46102-203R
KENWORTH	T600	CATERPILLAR C13	C3M46102-152R, AHH1000, C3M46102-203R, AHH250
KENWORTH	T600	CUMMINS ISX	AHP33250-36BL, C3M46102-152R, AHH1000, AHH750, AHP4543250-3BL, AHP33300-36BL, C3M46102-203R, AHH250
KENWORTH	T600	CUMMINS L10 DIESEL	AHP33250-36BL, AHP33300-36BL, C3M46102-152R, C3M46102-203R, AHH250
KENWORTH	T600	CUMMINS N14	AHP33250-36BL, AHP33300-36BL, C3M46102-152R, C3M46102-203R, AHH250
KENWORTH	T600	CUMMINS M11 DIESEL	AHP33250-36BL, AHP33300-36BL, C3M46102-152R, C3M46102-203R, AHH250
KENWORTH	T600	CUMMINS SIGNATURE 600	AHP33250-36BL, AHP33300-36BL, C3M46102-152R, C3M46102-203R
KENWORTH	T600	DETROIT DIESEL SERIE 60	AHP33250-36BL, C3M46102-152R, C3M46102-203R, AHH250
KENWORTH	T600	DETROIT DIESEL 6 CIL, 11.1 L	AHP33300-36BL, C3M46102-152R, C3M46102-203R, AHH250
KENWORTH	T600	DETROIT DIESEL 6 CIL, 12.7 L	AHP33250-36BL, AHP33300-36BL, C3M46102-152R, C3M46102-203R, AHH250
KENWORTH	T600	PACCAR MX	AHH750, C3M46102-152R, C3M46102-203R, AHH250
KENWORTH	T600	PACCAR MX-13	AHH750, C3M46102-152R, C3M46102-203R, AHH250
KENWORTH	T600B	CATERPILLAR 3176	C3M46102-152R, C3M46102-203R, AHH250
KENWORTH	T600B	CATERPILLAR C15	C3M46102-152R, AHP33200-36BL, C3M46102-203R, AHH250
KENWORTH	T600B	CUMMINS ISX	C3M46102-152R, C3M46102-152R, C3M46102-203R, AHH250
KENWORTH	T600B	CUMMINS N1	C3M46102-152R, C3M46102-203R, AHH250
KENWORTH	T660	CATERPILLAR C11	C5M4664-216BLM
KENWORTH	T660	CATERPILLAR C13	C5M4664-216BLM
KENWORTH	T660	CATERPILLAR C15	AHP33250-36BL, C5M4664-216BLM
KENWORTH	T660	CUMMINS ISL	C3M46102-152R, C5M4664-216BLM
KENWORTH	T660	CUMMINS ISM	C3M46102-152R, C5M4664-216BLM
KENWORTH	T660	CUMMINS ISX	AHP33250-36BL, C3M46102-152R, C5M4664-216BLM
KENWORTH	T680	CUMMINS ISX	AHP4543250-3BL, AHH1000, AHH750, C5M4664-216BLM
KENWORTH	T680	PACCAR MX	AHP4543250-3BL, AHH1000, AHH751, C5M4664-216BLM
KENWORTH	T680	CUMMINS ISX	AHP4543250-3BL, AHH1000, AHH752, C5M4664-216BLM
KENWORTH	T680	PACCAR MX-13	AHP4543250-3BL, C5M4664-216BLM
KENWORTH	T680	PACCAR MX-11	AHP4543250-3BL, C5M4664-216BLM
KENWORTH	T800	CATERPILLAR 3176	AHP33300-36BL, AHP33200-36BL, C3M46102-152R, C3M46102-203R, AHH250, C5M4664-216BLM
KENWORTH	T800	CATERPILLAR 3306	AHP33250-36BL, C3M46102-152R, C3M46102-203R, AHH250, C5M4664-216BLM
KENWORTH	T800	CATERPILLAR 3401	C3M46102-152R, C3M46102-203R, AHH250, C5M4664-216BLM
KENWORTH	T800	CATERPILLAR 3406B	AHP33250-36BL, C3M46102-152R, AHP33300-36BL, C3M46102-203R, AHH250, C5M4664-216BLM
KENWORTH	T800	CATERPILLAR 3406E	AHP33250-36BL, C3M46102-152R, C3M46102-203R, AHH250, C5M4664-216BLM
KENWORTH	T800	CATERPILLAR 3406TA	AHP33250-36BL, C3M46102-152R, C3M46102-203R, AHH250, C5M4664-216BLM
KENWORTH	T800	CATERPILLAR 3406TA (A)	AHP33250-36BL, C3M46102-152R, C3M46102-203R, AHH250, C5M4664-216BLM
KENWORTH	T800	CATERPILLAR 3406TA (B)	AHP33250-36BL, C3M46102-152R, C3M46102-203R, AHH250, C5M4664-216BLM
KENWORTH	T800	CATERPILLAR 3406TA (C)	AHP33250-36BL, C3M46102-152R, C3M46102-203R, AHH250, C5M4664-216BLM
KENWORTH	T800	CATERPILLAR C10	AHP33250-36BL, AHP33300-36BL, C3M46102-152R, C3M46102-203R, AHH250, C5M4664-216BLM
KENWORTH	T800	CATERPILLAR C12	AHP33250-36BL, AHP33300-36BL, C3M46102-152R, C3M46102-203R, AHH250, C5M4664-216BLM
KENWORTH	T800	CATERPILLAR C16	AHP33250-36BL, AHP33300-36BL, C3M46102-152R, C3M46102-203R, C5M4664-216BLM
KENWORTH	T800	CUMMINS FORMULA 10-240	C3M46102-152R, C3M46102-203R, AHH250, C5M4664-216BLM
KENWORTH	T800	CUMMINS ISL	C3M46102-152R, AHP33200-36BL, C3M46102-203R, AHH250, C5M4664-216BLM
KENWORTH	T800	CUMMINS ISM	AHP33250-36BL, C3M46102-152R, AHP4543250-3BL, AHP33300-36BL, C3M46102-203R, AHH250, C5M4664-216BLM

MARCA	MODELO	MOTOR	NÚMEROS DE PARTE AHE
KENWORTH	T800	CUMMINS ISX	AHP33250-36BL, C3M46102-152R, AHH750, AHP4543250-3BL, C3M46102-203R, AHP33300-36BL, AHH250, C5M4664-216BLM
KENWORTH	T800	CUMMINS L10	AHP33250-36BL, AHP33300-36BL, C3M46102-152R, C3M46102-203R, AHH250, C5M4664-216BLM
KENWORTH	T800	CUMMINS M11	AHP33250-36BL, AHP33300-36BL, C3M46102-152R, C3M46102-203R, AHH250, C5M4664-216BLM
KENWORTH	T800	CUMMINS N14	AHP33250-36BL, AHP33300-36BL, C3M46102-152R, C3M46102-203R, AHH250, C5M4664-216BLM
KENWORTH	T800	DETROIT DIESEL SERIE 60	AHP33250-36BL, C3M46102-152R, C3M46102-203R, AHH250, C5M4664-216BLM
KENWORTH	T800	DETROIT DIESEL 6 CIL. 11.1 L DIESEL	AHP33250-36BL, AHP33300-36BL, C3M46102-152R, C3M46102-203R, AHH250, C5M4664-216BLM
KENWORTH	T800	DETROIT DIESEL 6 CIL. 12.7 L	AHP33300-36BL, C3M46102-152R, C3M46102-203R, AHH250, C5M4664-216BLM
KENWORTH	T800	PACCAR MX-13	C3M46102-152R, AHP4543250-3BL, C3M46102-203R, AHH250, C5M4664-216BLM
KENWORTH	T800	PACCAR MX-11	AHP4543250-3BL, C3M46102-152R, C3M46102-203R, AHH250, C5M4664-216BLM
KENWORTH	T800	PACCAR MX	AHP4543250-3BL, AHH1000, C3M46102-152R, C3M46102-203R, AHH250, C5M4664-216BLM
KENWORTH	T800	WSETPORT GX 2011 -2012	AHP4543250-3BL, C3M46102-152R, C3M46102-203R, AHH250, C5M4664-216BLM
KENWORTH	T800B	CATERPILLAR C11	AHP33250-36BL, AHP33300-36BL, C3M46102-152R, C3M46102-203R, AHH250
KENWORTH	T800B	CATERPILLAR C13	C3M46102-152R, C3M46102-203R, AHH250
KENWORTH	T800B	CATERPILLAR C15	AHP33250-36BL, C3M46102-152R, AHP33300-36BL, C3M46102-203R, AHH250
KENWORTH	T800B	CATERPILLAR ISL	AHP33250-36BL, C3M46102-152R, C3M46102-203R, AHH250
KENWORTH	T800B	CATERPILLAR ISM	C3M46102-152R, C3M46102-203R, AHH250
KENWORTH	T800B	CATERPILLAR ISX	C3M46102-152R, C3M46102-203R, AHH250
KENWORTH	T800B	CATERPILLAR M11	C3M46102-152R, C3M46102-203R, AHH250
KENWORTH	T880	PACCAR MX-13	C3M46102-152R, AHH1000, C5M4664-216BLM
KENWORTH	W900	CATERPILLAR C10 DIESEL	AHP33300-36BL, C3M46102-152R, C3M46102-203R, AHH250, C5M4664-216BLM
KENWORTH	W900	CATERPILLAR C13	AHP33250-36BL, C3M46102-152R, C3M46102-203R, AHH250, C5M4664-216BLM
KENWORTH	W900	CATERPILLAR C11 DIESEL	AHP33250-36BL, AHP33300-36BL, C3M46102-152R, C3M46102-203R, AHH250, C5M4664-216BLM
KENWORTH	W900	CATERPILLAR C15	AHP33250-36BL, AHP33300-36BL, C3M46102-152R, C3M46102-203R, AHH250, C5M4664-216BLM
KENWORTH	W900	CATERPILLAR C16 DIESEL	AHP33250-36BL, AHP33300-36BL, C3M46102-152R, C3M46102-203R, AHH250, C5M4664-216BLM
KENWORTH	W900	CATERPILLAR 3406TA	AHP33250-36BL, AHP33300-36BL, C3M46102-152R, C3M46102-203R, AHH250, C5M4664-216BLM
KENWORTH	W900	CUMMINS ISX	AHP33250-36BL, C3M46102-152R, AHP9043250-6BL, AHH1000, AHH750, AHP4543250-3BL, C3M46102-203R, AHH250, C5M4664-216BLM
KENWORTH	W900	PACCAR MX-13	AHP4543250-3BL, C3M46102-152R, C3M46102-203R, AHH250, C5M4664-216BLM
KENWORTH	W900	PACCAR PX-9	AHP4543250-3BL, C3M46102-152R, C3M46102-203R, AHH250, C5M4664-216BLM
KENWORTH	W900	PACCAR MX	AHP4543250-3BL, C3M46102-152R, C3M46102-203R, AHH250, C5M4664-216BLM
KENWORTH	W900	DETROIT DIESEL SERIE 60	AHP33250-36BL, C3M46102-152R, C3M46102-203R, AHH250, C5M4664-216BLM
KENWORTH	W900	DETROIT DIESEL 6 CIL. 11.1 L	AHP33300-36BL, C3M46102-152R, C3M46102-203R, AHH250, C5M4664-216BLM
KENWORTH	W900	DETROIT DIESEL 6 CIL. 12.7 L	AHP33250-36BL, AHP33300-36BL, C3M46102-203R, C3M46102-152R, AHH250, C5M4664-216BLM
KENWORTH	W900	CUMMINS ISL-G	AHP4543250-3BL, C3M46102-152R, C3M46102-203R, AHH250, C5M4664-216BLM
KENWORTH	L700	CATERPILLAR 3208	AHP33250-36BL
KENWORTH	L700	CATERPILLAR 3206	AHP33250-36BL
KENWORTH	L700	CUMMINS FORMULA 10-240	AHP33250-36BL
KENWORTH	L700	PACCAR PX-6	C346300-6R
KENWORTH	L700	PACCAR PX8	AHP33250-36BL
KENWORTH	C500	CATERPILLAR 3176 DIESEL	AHP33250-36BL, AHP33200-36BL, AHP33300-36BL
KENWORTH	C500	CATERPILLAR 3306 DIESEL	AHP33250-36BL, C5M4664-216BLM
KENWORTH	K100	CUMMINS 6 CIL. 14.0 L DIESEL	AHP33250-36BL, AHP33300-36BL
KENWORTH	K100	DETROIT DIESEL 6 CIL. 12.7 L	AHP33250-36BL, AHP33300-36BL
KENWORTH	T2000	CATERPILLAR C16 DIESEL	AHP33250-36BL, AHP33300-36BL
KENWORTH	T450	CUMMINS L10 DIESEL	AHP33250-36BL, AHP33300-36BL
KENWORTH	T450	CUMMINS M11 DIESEL	AHP33250-36BL, AHP33300-36BL
KENWORTH	T600	CUMMINS 6 CIL. 14.0 L DIESEL	AHP33250-36BL, C3M46102-152R, C3M46102-203R, AHH250

MARCA	MODELO	MOTOR	NÚMEROS DE PARTE AHE
KENWORTH	T800	CATERPILLAR C13	AHP33250-36BL, AHP33300-36BL, C3M46102-152R, C3M46102-203R, AHH250, C5M4664-216BLM
KENWORTH	W900	CATERPILLAR C12 DIESEL	AHP33300-36BL, C3M46102-152R, C3M46102-203R, AHH250, C5M4664-216BLM
KENWORTH	W900	CUMMINS ISM DIESEL	AHP33250-36BL, AHP33300-36BL, C3M46102-152R, C3M46102-203R, AHH250, C5M4664-216BLM
KENWORTH	W900	CUMMINS 6 CIL. 14.0 L DIESEL	AHP33250-36BL, AHP33300-36BL, C3M46102-152R, C3M46102-203R, AHH250
KENWORTH	W900	CUMMINS N14 DIESEL	AHP33250-36BL, C3M46102-152R, C3M46102-203R, AHH250, C5M4664-216BLM
KENWORTH	W900	CUMMINS SIGNATURE 600	AHP33250-36BL, C3M46102-152R, C3M46102-203R, AHH250, C5M4664-216BLM
MACK	CV SERIES	MACK AI	AHP33200-36BL, AHP33250-36BL
MACK	CV SERIES	MACK AMI	AHP33200-36BL, AHP33250-36BL
MACK	CS SERIES	MACK AC	AHP33200-36BL, AHP33250-36BL
MACK	CV SERIES	MACK 6 CIL. 12.0 L	AHP33200-36BL, AHP33250-36BL
MACK	MR SERIES	MACK 6 CIL. 12.0 L	AHP33200-36BL, AHP33250-36BL
MACK	MRU SERIES	2007 - 2017	C346350-6R
MACK	GU SERIES	2012 - 2017	C346350-6R
MACK	RD SERIES	MACK 6 CIL. 12.0 L	AHP33200-36BL, AHP33250-36BL
MACK	TD SERIES	2011 -2017	C346350-6R
MACK	LEU SERIES	2010 - 2016	C346350-6R
MACK	LEU SERIES	2016 -2017	C346350-6R
MACK	CH SERIES	MACK AC	AHP33200-36BL
MACK	CH SERIES	MACK 6 CIL. 12.0 L	AHP33200-36BL, AHP33250-36BL
MACK	CHN SERIES	MACK AC	AHP33250-36BL
MACK	CHU SERIES	2014	C346350-6R
MACK	CHU SERIES	2015	C346350-6R
MACK	CHU SERIES	2016	C346350-6R
MACK	CX SERIES	MACK AC	AHP33200-36BL
MACK	CX SERIES	MACK 6 CIL. 12.0 L	AHP33200-36BL, AHP33250-36BL
MACK	CXP SERIES	MACK MP7	AHP33250-36BL
MACK	CXU SERIES	2008	C346350-6R
MACK	CXU SERIES	2009	C346350-6R
MACK	CXU SERIES	2010	C346350-6R
MACK	CXU SERIES	3013	C346350-6R
MACK	CXU SERIES	2014	C346350-6R
MACK	CXU SERIES	2015	C346350-6R
MACK	CXU SERIES	2016	C346350-6R
MACK	CT SERIES	MACK AI	AHP33250-36BL
MACK	CTP SERIES	MACK MP7	AHP33250-36BL, C346350-6R
MACK	CL SERIES	CUMMINS ISX	AHP33250-36BL, AHP33300-36BL
MERCEDES BENZ	TORETO	MERCEDES BENZ OM 924 LA	C3M3676-140B
MERCEDES BENZ	BOXER	MERCEDES BENZ OM 924 LA MOTOR FRONT.	C3M3676/89-140B
MERCEDES BENZ	BOXER OF	MERCEDES BENZ OM 924 LA MOTOR FRONT.	C3M3676/89-140B, C3M4680-155R, C6M46102-254R, C746400-12.5, M45100-70-FL
MERCEDES BENZ	BOXER (DESDE 2011)	MERCEDES BENZ OM 904 LA	C4M3670-170R
MERCEDES BENZ	BOXER 2009	MERCEDES BENZ OM 904 LA	C4M3670-170R, AHP4543300-3BL, AHP9053400-6BL, AHH1000, AHH750
MERCEDES BENZ	BOXER MBO 1219/52	MERCEDES BENZ OM 904 LA	C4M3670-170R, AHP4543300-3BL, AHP9053400-6BL, AHH1000, AHH750
MERCEDES BENZ	BOXER MBO 1319	MERCEDES BENZ OM 924	C3M3676/89-140B, C3M4680-155R
MERCEDES BENZ	TORINO	MERCEDES BENZ OM 924 LA MOTOR TRASERO	C3M3676/89-140B
MERCEDES BENZ	TORINO	MERCEDES BENZ OM906 LA	C8M3689-305R
MERCEDES BENZ	TORINO OH 1523	MERCEDES BENZ OM906	C8M3689-305R
MERCEDES BENZ	TORINO OH 1623/52L	MERCEDES BENZ OM906	C8M3689-305R
MERCEDES BENZ	VIAGGIO 900	MERCEDES BENZ OM 457 LA 6 CIL	C346250-6RM
MERCEDES BENZ	VIAGGIO 1050	MERCEDES BENZ OM457	AHP9043400-6BL
MERCEDES BENZ	SAFETY BUS	MERCEDES BENZ OM 457 LA 6 CIL	C346250-6RM
MERCEDES BENZ	PARADISO 1200	MERCEDES BENZ OM 457 LA 6 CIL	C346250-6RM
MERCEDES BENZ	PARADISO 1800 DD	MERCEDES BENZ OM 457 LA 6 CIL	C346250-6RM
MERCEDES BENZ	PARADISO 1350	MERCEDES BENZ OM457	AHP9043400-6BL
MERCEDES BENZ	13T-SERIE -1318	MERCEDES BENZ OM 904 LA	C4M3670-170R
MERCEDES BENZ	14T-SERIE 1418 L/EL	MERCEDES BENZ OM 904 LA	C4M3670-170R
MERCEDES BENZ	16T-SERIE-1620L	MERCEDES BENZ OM 904 LA	C4M3670-170R
PETERBILT	337	PACCAR PX-9	C3M46102-203R, C5M4664-216BLM
PETERBILT	337	PACCAR PX-9	C3M46102-203R, C5M4664-216BLM

MARCA	MODELO	MOTOR	NÚMEROS DE PARTE AHE
PETERBILT	337	CUMMINS PX-9	C3M46102-203R, C5M4664-216BLM
PETERBILT	337	PACCAR PX-9	C3M46102-203R, C5M4664-216BLM
PETERBILT	337	CUMMINS PX-9	C3M46102-203R, C5M4664-216BLM
PETERBILT	337	PACCAR PX-9	C3M46102-203R, C5M4664-216BLM
PETERBILT	348	CUMMINS PX-9	C3M46102-203R, C5M4664-216BLM
PETERBILT	348	PACCAR PX-9	C3M46102-203R, C5M4664-216BLM
PETERBILT	348	CUMMINS PX-9	C3M46102-203R, C5M4664-216BLM
PETERBILT	348	CUMMINS PX-9	C3M46102-203R, C5M4664-216BLM
PETERBILT	348	PACCAR PX-9	C3M46102-203R, C5M4664-216BLM
PETERBILT	348	PACCAR PX-9	C3M46102-203R, C5M4664-216BLM
PETERBILT	348	CUMMINS PX-9	C3M46102-203R, C5M4664-216BLM
PETERBILT	365	CATERPILLAR C13	C3M46102-152R, C5M4664-216BLM
PETERBILT	365	CUMMINS ISX 11.9 -V	AHP4543250-3BL, C5M4664-216BLM
PETERBILT	365	CUMMINS ISX 11.9	AHP4543250-3BL, C5M4664-216BLM
PETERBILT	365	CUMMINS ISX	AHP4543250-3BL, C5M4664-216BLM
PETERBILT	365	CUMMINS ISX 12	AHP4543250-3BL, C5M4664-216BLM
PETERBILT	365	CUMMINS ISX 12 - G	AHP4543250-3BL, C5M4664-216BLM
PETERBILT	365	CUMMINS ISX 12 - N	AHP4543250-3BL, C5M4664-216BLM
PETERBILT	365	CUMMINS ISL	AHP4543250-3BL, C5M4664-216BLM
PETERBILT	365	CUMMINS ISL-G	AHP4543250-3BL, C5M4664-216BLM
PETERBILT	365	PACCAR MX	AHP4543250-3BL, C5M4664-216BLM
PETERBILT	365	PACCAR MX-11	AHP4543250-3BL, C5M4664-216BLM
PETERBILT	365	PACCAR MX-13	AHP4543250-3BL, C5M4664-216BLM
PETERBILT	367	CUMMINS ISX 12	AHP4543250-3BL, C5M4664-216BLM
PETERBILT	367	CUMMINS ISX 12 - G	AHP4543250-3BL, C5M4664-216BLM
PETERBILT	367	CUMMINS ISX 11.9-V	AHP4543250-3BL, C5M4664-216BLM
PETERBILT	367	CUMMINS ISX 11.9	AHP4543250-3BL, C5M4664-216BLM
PETERBILT	367	CUMMINS X 15	AHP4543250-3BL, C5M4664-216BLM
PETERBILT	367	CUMMINS ISX	AHP4543250-3BL, C5M4664-216BLM
PETERBILT	367	CUMMINS ISX 15 E4	AHP4543250-3BL, C5M4664-216BLM
PETERBILT	367	CUMMINS ISX 15 LTS 6 CIL	AHP4543250-3BL, AHH750, C5M4664-216BLM
PETERBILT	367	CUMMINS ISX QSX15	AHP4543250-3BL, C5M4664-216BLM
PETERBILT	367	PACCAR MX	AHP4543250-3BL, C5M4664-216BLM
PETERBILT	367	CATERPILLAR C15	C3M46102-152R, C5M4664-216BLM
PETERBILT	367	CATERPILLAR C13	C3M46102-152R, C5M4664-216BLM
PETERBILT	382	PACCAR PX-9	AHP4543250-3BL
PETERBILT	384	CUMMINS ISL	AHP4543250-3BL, C5M4664-216BLM
PETERBILT	384	CUMMINS ISL-G	AHP4543250-3BL, C5M4664-216BLM
PETERBILT	384	CUMMINS ISX	AHP4543250-3BL, C5M4664-216BLM
PETERBILT	384	CUMMINS ISX 12 - N	AHP4543250-3BL, C5M4664-216BLM
PETERBILT	384	CUMMINS ISX 12 - G	AHP4543250-3BL, C5M4664-216BLM
PETERBILT	384	CUMMINS ISX 11.9-V	AHP4543250-3BL, C5M4664-216BLM
PETERBILT	384	CUMMINS ISX 11.9	AHP4543250-3BL, C5M4664-216BLM
PETERBILT	384	CATERPILLAR C13	C3M46102-152R, C5M4664-216BLM
PETERBILT	384	PACCAR MX	AHP4543250-3BL, C5M4664-216BLM
PETERBILT	384	PACCAR MX-9	AHP4543250-3BL, C5M4664-216BLM
PETERBILT	384	PACCAR MX-13	AHP4543250-3BL, C5M4664-216BLM
PETERBILT	386	CATERPILLAR C15	C3M46102-152R, C5M4664-216BLM
PETERBILT	386	CATERPILLAR C13	C3M46102-152R, C5M4664-216BLM
PETERBILT	386	PACCAR MX 13	AHH1000, AHP4543250-3BL, C3M46102-152R, C5M4664-216BLM
PETERBILT	386	PACCAR MX	AHH1000, AHP4543250-3BL, C5M4664-216BLM
PETERBILT	386	WESTPORT GX	AHP4543250-3BL, C5M4664-216BLM
PETERBILT	386	CUMMINS X 15	AHP4543250-3BL, C5M4664-216BLM
PETERBILT	386	CUMMINS QSX15	AHP4543250-3BL, C5M4664-216BLM
PETERBILT	386	CUMMINS ISX 11.9-V	AHP4543250-3BL, C5M4664-216BLM
PETERBILT	386	CUMMINS ISX 11.9	AHP4543250-3BL, C5M4664-216BLM
PETERBILT	386	CUMMINS ISX	AHP4543250-3BL, C5M4664-216BLM
PETERBILT	386	CUMMINS ISX 12	AHP4543250-3BL, C5M4664-216BLM
PETERBILT	386	CUMMINS ISX 12-G	AHP4543250-3BL, C5M4664-216BLM
PETERBILT	386	CUMMINS ISX 15 LTS 6 CIL	AHH750, AHH1000, C5M4664-216BLM
PETERBILT	387	CUMMINS QSX15	AHP4543250-3BL, C5M4664-216BLM

MARCA	MODELO	MOTOR	NÚMEROS DE PARTE AHE
PETERBILT	387	CUMMINS ISX 15	AHP4543250-3BL, C5M4664-216BLM
PETERBILT	387	CUMMINS ISX	AHP4543250-3BL, C5M4664-216BLM
PETERBILT	387	CATERPILLAR C13	C3M46102-152R, C5M4664-216BLM
PETERBILT	387	CATERPILLAR C15	C3M46102-152R, C5M4664-216BLM
PETERBILT	388	CATERPILLAR C15	C3M46102-152R, C5M4664-216BLM
PETERBILT	388	CATERPILLAR C13	C3M46102-152R, C5M4664-216BLM
PETERBILT	388	CUMMINS ISX 15 LTS 6 CIL	AHH750, AHH1000, C5M4664-216BLM
PETERBILT	388	CUMMINS ISX 12	AHP4543250-3BL, C5M4664-216BLM
PETERBILT	388	CUMMINS ISX 12-G	AHP4543250-3BL, C5M4664-216BLM
PETERBILT	388	CUMMINS ISX 11.9-V	AHP4543250-3BL, C5M4664-216BLM
PETERBILT	388	CUMMINS ISX 11.9	AHP4543250-3BL, C5M4664-216BLM
PETERBILT	388	CUMMINS ISX	AHP4543250-3BL, C5M4664-216BLM
PETERBILT	388	CUMMINS X 15	AHP4543250-3BL, C5M4664-216BLM
PETERBILT	388	CUMMINS QSX15	AHP4543250-3BL, C5M4664-216BLM
PETERBILT	389	CUMMINS ISX 15 LTS 6 CIL	AHH750, AHH1000, C5M4664-216BLM
PETERBILT	389	CUMMINS ISX 12	AHP4543250-3BL, C5M4664-216BLM
PETERBILT	389	CUMMINS ISX 12 - G	AHP4543250-3BL, C5M4664-216BLM
PETERBILT	389	CUMMINS ISX	AHP4543250-3BL, C5M4664-216BLM
PETERBILT	389	CUMMINS X 15	AHP4543250-3BL, C5M4664-216BLM
PETERBILT	389	PACCAR MX -13	AHP4543250-3BL, C3M46102-152R, C5M4664-216BLM
PETERBILT	389	PACCAR MX	AHP4543250-3BL, C5M4664-216BLM
PETERBILT	389	CATERPILLAR C15	C3M46102-152R, C5M4664-216BLM
PETERBILT	365	CATERPILLAR C13	C3M46102-152R, C5M4664-216BLM
PETERBILT	365	CUMMINS PX-9	AHP4543250-3BL, C5M4664-216BLM
PETERBILT	367	CATERPILLAR C13	C3M46102-152R, C5M4664-216BLM
PETERBILT	367	CATERPILLAR C15	C3M46102-152R, C5M4664-216BLM
PETERBILT	367	WESTPORT GX	AHP4543250-3BL, C5M4664-216BLM
PETERBILT	367	PACCAR MX 13	AHP4543250-3BL, C3M46102-152R, C5M4664-216BLM
PETERBILT	384	CATERPILLAR C13	C3M46102-152R, C5M4664-216BLM
PETERBILT	384	CUMMINS ISX 12	AHP4543250-3BL, C5M4664-216BLM
PETERBILT	387	CATERPILLAR C15	C3M46102-152R, C5M4664-216BLM
PETERBILT	567	CUMMINS ISX 15 LTS 6 CIL	AHP4543250-3BL, C5M4664-216BLM
PETERBILT	567	CUMMINS ISX 12	AHP4543250-3BL, C5M4664-216BLM
PETERBILT	567	CUMMINS ISX 12 - G	AHP4543250-3BL, C5M4664-216BLM
PETERBILT	567	CUMMINS ISX 12 - N	AHP4543250-3BL, C5M4664-216BLM
PETERBILT	567	CUMMINS ISX	AHP4543250-3BL, C5M4664-216BLM
PETERBILT	567	CUMMINS X 15	AHP4543250-3BL, C5M4664-216BLM
PETERBILT	567	CUMMINS PX-9	AHP4543250-3BL, C5M4664-216BLM
PETERBILT	567	PACCAR MX 13	AHP4543250-3BL, C3M46102-152R, C5M4664-216BLM
PETERBILT	567	PACCAR MX 11	AHP4543250-3BL, C5M4664-216BLM
PETERBILT	567	PACCAR MX	AHP4543250-3BL, C5M4664-216BLM
PETERBILT	567	PACCAR TMK4	AHP4543250-3BL, C5M4664-216BLM
PETERBILT	579	CUMMINS ISX 12-G	AHP4543250-3BL, C5M4664-216BLM
PETERBILT	579	CUMMINS ISX 12-N	AHP4543250-3BL, C5M4664-216BLM
PETERBILT	579	CUMMINS ISX 12	AHP4543250-3BL, C5M4664-216BLM
PETERBILT	579	CUMMINS ISX 15 LTS 6 CIL	AHH1000, AHP4543250-3BL, C5M4664-216BLM
PETERBILT	579	CUMMINS ISX	AHP4543250-3BL, C5M4664-216BLM
PETERBILT	579	CUMMINS X 15	AHP4543250-3BL, C5M4664-216BLM
PETERBILT	579	CUMMINS PX 9	AHP4543250-3BL, C5M4664-216BLM
PETERBILT	579	PACCAR MX	AHP4543250-3BL, C5M4664-216BLM
PETERBILT	579	PACCAR MX - 11	AHP4543250-3BL, C5M4664-216BLM
PETERBILT	579	PACCAR MX 13	AHH750, AHP4543250-3BL, C3M46102-152R, C5M4664-216BLM
PETERBILT	579	PACCAR TMK4	AHP4543250-3BL, C5M4664-216BLM
PETERBILT	579	CUMMINS ISX 15 E4	AHP4543250-3BL, C5M4664-216BLM
PETERBILT	587	CUMMINS ISX	AHP4543250-3BL, C5M4664-216BLM
PETERBILT	587	CUMMINS ISX 15 LTS 6 CIL	AHH1000, AHH750, AHP4543250-3BL, C5M4664-216BLM
PETERBILT	388	PACCAR MX 13	AHP4543250-3BL, C3M46102-152R, C5M4664-216BLM
PETERBILT	388	PACCAR MX	AHP4543250-3BL, C5M4664-216BLM
PETERBILT	388	WESTPORT GX	AHP4543250-3BL, C5M4664-216BLM
SCANIA	CHASIS SERIE K	SCANIA 9 LITROS	AHH750
SCANIA	CHASIS SERIE K	SCANIA 13 LITROS	AHH750
SCANIA	CHASIS SERIE F	SCANIA 13 LITROS	AHH750

MARCA	MODELO	MOTOR	NÚMEROS DE PARTE AHE
SCANIA	CHASIS SERIE K	SCANIA 13 LITROS	AHH750
SCANIA	SERIE P, S, R Y G	SCANIA 9 LITROS	C3M3676-140R, AHH750
SCANIA	SERIE P, S, R Y G	SCANIA 13 LITROS	C3M3676-140R, AHH750
SCANIA	SERIE P, S, R Y G	SCANIA 16 LITROS	C3M3676-140R, AHH750
SCANIA	T124GA 6X4 NA 400	SCANIA DSC12	AHH750
SCANIA	T124GA 6X4 NA 400	DAIMLER CHRYSLER 11 06	AHH750
SCANIA	T124GA 6X4 NA 400	DAIMLER CHRYSLER 12 02	AHH750
SCANIA	IRIZAR I4/I4H/I4LE/16	SCANIA DC12 13 380	C2M4661/75-136RM, C2M4689-140RM, AHH750, AHP9053200-6BL
SCANIA	IRIZAR I4/I4H/I4LE/16	SCANIA DC12-10 340	C2M4661/75-136RM, C2M4689-140RM, AHH750, AHP9053200-6BL
SCANIA	IRIZAR I4/I4H/I4LE/16	SCANIA DC9-17 270	C2M4661/75-136RM, C2M4689-140RM, AHH750, AHP9053200-6BL
SCANIA	IRIZAR I4/I4H/I4LE/16	SCANIA DC9 22/32 320	C2M4661/75-136RM, C2M4689-140RM, AHH750, AHP9053200-6BL
SCANIA	IRIZAR I4/I4H/I4LE/16	SCANIA DC9 24 360	C2M4661/75-136RM, C2M4689-140RM, AHH750, AHP9053200-6BL
SCANIA	IRIZAR I4/I4H/I4LE/16	SCANIA DC9 18 310	C2M4661/75-136RM, C2M4689-140RM, AHH750, AHP9053200-6BL
SCANIA	IRIZAR I4/I4H/I4LE/16	DC9 29/36 280	C2M4661/75-136RM, C2M4689-140RM, AHH750, AHP9053200-6BL
SCANIA	K114 IB 4X2 NB	DAIMLER CHRYSLER 11 06	AHH750
SCANIA	K114 IB 4X2 NB	DAIMLER CHRYSLER 12 06	AHH750
SCANIA	K114 IB 4X2 NB	DAIMLER CHRYSLER 12 02	AHH750
SCANIA	K114 IB 4X2 NB	SCANIA DC11 EURO3	AHH750
SCANIA	K114 IB 4X2 NB	SCANIA DSC11	AHH750
SCANIA	K114 IB 4X2 NB	SCANIA DC12 EURO04	AHH750
SCANIA	K114 IB 4X2 NB	DCS12	AHH750
SCANIA	T113 H 6X4	DSC11	AHH750
STERLING	ACTERRA 7500	CATERPILLAR 3126B	AHP33200-36BL, AHP33250-36BL, C346300-6R
STERLING	ACTERRA	CATERPILLAR C13	AHP33250-36BL, C346300-6R
STERLING	ACTERRA M6500	CUMMINS ISB	AHP33200-36BL, C346300-6R
STERLING	ACTERRA M6500	CUMMINS ISC	AHP33200-36BL, C346300-6R
STERLING	ACTERRA M6500	MERCEDES BENZ MBE900	AHP33200-36BL,
STERLING	ACTERRA M7500	CUMMINS ISB	AHP33200-36BL, C346300-6R
STERLING	ACTERRA M7500	CUMMINS ISC	AHP33200-36BL, C346300-6R
STERLING	ACTERRA M8500	CUMMINS ISB	AHP33200-36BL, C346300-6R
STERLING	ACTERRA M8500	CUMMINS ISC	AHP33200-36BL, C346300-6R
STERLING	CONDOR	2002 -2007	C346350-6R
STERLING	L-LINE	CUMMINS N14 DIESEL	AHP33250-36BL, C346300-6R
STERLING	L-LINE	CATERPILLAR 3406	AHP33250-36BL, AHP33300-36BL, C346300-6R
STERLING	L-LINE	CATERPILLAR C9	AHP33250-36BL, C346300-6R
STERLING	L-LINE	CATERPILLAR C13	AHP33250-36BL, C346300-6R
STERLING	L-LINE	CATERPILLAR C15	AHP33250-36BL, C346300-6R
STERLING	A-LINE	CATERPILLAR 3406	AHP33250-36BL, AHP33300-36BL
STERLING	L-LINE	CUMMINS ISM	AHP33200-36BL, AHP33250-36BL, C346300-6R
STERLING	L-LINE	CUMMINS ISX DIESEL	AHP33250-36BL, C346300-6R
STERLING	L-LINE	CUMMINS SIGNATURE 600	AHP33250-36BL, C346300-6R
STERLING	L-LINE	CATERPILLAR 3126	AHP33200-36BL, AHP33250-36BL, C346300-6R
STERLING	L-LINE	CATERPILLAR C10	AHP33250-36BL, C346300-6R
STERLING	L-LINE	CATERPILLAR C12	AHP33250-36BL, C346300-6R
STERLING	L-LINE	DETROIT DIESEL 6 CIL, 11.1 L	AHP33250-36BL, C346350-6R
STERLING	L-LINE	DETROIT DIESEL 6 CIL, 12.7 L	AHP33250-36BL, C346350-6R
STERLING	L-LINE	DETROIT DIESEL 6 CIL, 14.0 L	AHP33250-36BL, C346350-6R
STERLING	L-LINE	MERCEDES BENZ MBE 4000	AHP33250-36BL, C346350-6R
STERLING	SC 8000	2006 - 2007	C346350-6R
STERLING	A-LINE	CATERPILLAR C13	AHP33250-36BL
STERLING	A-LINE	CATERPILLAR C12	AHP33250-36BL
STERLING	A-LINE	CATERPILLAR C10	AHP33250-36BL
STERLING	A-LINE	DETROIT DIESEL 6 CIL, 11.1 L	AHP33250-36BL
STERLING	A-LINE	DETROIT DIESEL 6 CIL, 12.7 L	AHP33250-36BL
STERLING	A-LINE	DETROIT DIESEL 6 CIL, 14.0 L	AHP33250-36BL
STERLING	A-LINE	CUMMINS ISM	AHP33250-36BL, AHP33200-36BL
STERLING	A-LINE	CUMMINS N14	AHP33250-36BL
STERLING	A-LINE	MERCEDES BENZ MBE 4000	AHP33250-36BL
VOLVO	AUTOCAR	DETROIT DIESEL 6 CIL, 11.1 L	AHP33250-36BL, AHP33300-36BL

MARCA	MODELO	MOTOR	NÚMEROS DE PARTE AHE
VOLVO	VOLVO VNR	VOLVO D13	C3M46102-152R
VOLVO	VOLVO VNL	VOLVO D11	C3M46102-152R
VOLVO	VOLVO VNL	VOLVO D13	C3M46102-152R
VOLVO	VOLVO VNL	CUMMINS ISX 15 LTS 6 CIL	C3M46102-152R, AHP33275-36BL, AHP33250-36BL
VOLVO	VNL64T	CUMMINS ISM	C3M46102-152R
VOLVO	VNL64T	CUMMINS ISX	C3M46102-152R
VOLVO	VOLVO VAH	VOLVO D13	C3M46102-152R, C346350-6R
VOLVO	VOLVO 7300	VOLVO DH12E	C3M46102-152R, AHH750
VOLVO	VOLVO ACCESS	VOLVO D8C	C3M46102-152R
VOLVO	VOLVO PRO CITY	VOLVO D8C	C3M46102-152R
VOLVO	VOLVO 9700	VOLVO D13C	C3M46102-152R, AHH750, AHH1000
VOLVO	VOLVO 9700	VOLVO DH12	C3M46102-152R, AHH750, AHH1000
VOLVO	VOLVO 9700	VOLVO DH12 D	C3M46102-152R, AHH750, AHH1000
VOLVO	9700 FL	B12	C6M46102-228R
VOLVO	9700	B12	C6M46102-228R
VOLVO	VOLVO 9700 GRAND	VOLVO D13	C3M46102-152R, AHH750, AHH1000
VOLVO	VOLVO 9800	VOLVO D13	C3M46102-152R
VOLVO	VOLVO 9800 DD	VOLVO D13	C3M46102-152R
VOLVO	7550	VOLVO VED12	C6M46102-228R
VOLVO	7550 FL	B12	C6M46102-228R
VOLVO	BUSSCAR	DETROIT DIESEL SERIE 60	C3M46102-152R
VOLVO	C11R	DETROIT DIESEL SERIE 60	C3M46102-152R
VOLVO	VHD	VOLVO VED12	C346350-6R
VOLVO	VN 630	VOLVO VED12	C346350-6R
VOLVO	WIA SERIES	CUMMINS L10	AHP33250-36BL
VOLVO	WIA SERIES	DETROIT DIESEL 6 CIL, 11.1 L	AHP33250-36BL
VOLVO	AUTOCAR	CUMMINS ISM	AHP33250-36BL
VOLVO	AUTOCAR	CUMMINS N14	AHP33250-36BL
VOLVO	AUTOCAR	DETROIT DIESEL 6 CIL, 12.7 L	AHP33250-36BL, AHP33300-36BL
VOLVO	VOLVO VNL	CUMMINS ISM	AHP33250-36BL, C3M46102-152R
VOLVO	VOLVO VNL	CUMMINS SIGNATURE 600	AHP33250-36BL, C3M46102-152R
VOLVO	VOLVO VNL	CUMMINS N14	AHP33250-36BL, C3M46102-152R
VOLVO	VOLVO VNL	CATERPILLAR 3406	AHP33250-36BL, AHP33300-36BL, C3M46102-152R
VOLVO	VOLVO VNL	DETROIT DIESEL 6 CIL, 11.1 L	AHP33250-36BL, C3M46102-152R
VOLVO	VOLVO VNL	DETROIT DIESEL 6 CIL, 12.7 L	AHP33250-36BL, C3M46102-152R
VOLVO	VNM	CUMMINS ISX DIESEL	AHP33275-36BL
VOLVO	WG SERIES	CUMMINS ISM	AHP33250-36BL, AHP33300-36BL
VOLVO	WG SERIES	DETROIT DIESEL 6 CIL, 12.7 L	AHP33250-36BL
VOLVO	WG SERIES	CUMMINS L10	AHP33250-36BL
VOLVO	WG SERIES	CUMMINS M11	AHP33250-36BL, AHP33300-36BL
VOLVO	WG SERIES	CUMMINS N14	AHP33250-36BL
VOLVO	WG SERIES	CATERPILLAR 3306	AHP33250-36BL
VOLVO	WG SERIES	CATERPILLAR 3406	AHP33250-36BL
VOLVO	WIA SERIES	CUMMINS ISM	AHP33250-36BL
VOLVO	WIA SERIES	CATERPILLAR 3406	AHP33250-36BL, AHP33300-36BL
VOLVO	WCA SERIES	CUMMINS M11	AHP33250-36BL
VOLVO	WAH	DETROIT DIESEL SERIE 60	AHH750
VOLVO	XPEDITOR	CATERPILLAR 3306	AHP33250-36BL
VOLVO	XPEDITOR	CUMMINS L10	AHP33250-36BL
VOLVO	XPEDITOR	CUMMINS ISL	AHH750, AHH1000
MOTOR MARINO	DETROIT DIESEL MARINO	DETROIT DIESEL MARINO 6V53 / 8V53 / 6-71 / 6V71 / 8V71 / 12V71 / 16V71 / 6V92 / 8 V92 / 12V92 / 16V92	M4689-70R
MOTOR MARINO	DETROIT DIESEL MARINO	DETROIT DIESEL MARINO 6V53 / 8V53 / 6-71 / 6V71 / 8V71 / 12V71 / 16V71 / 6V92 / 8 V92 / 12V92 / 16V92	AHP33312-36BL
MOTOR MARINO	DETROIT DIESEL MARINO	DETROIT DIESEL MARINO 6V53 / 8V53 / 6-71 / 6V71 / 8V71 / 12V71 / 16V71 / 6V92 / 8 V92 / 12V92 / 16V92	AHP33350-36BL
MOTOR MARINO	DETROIT DIESEL MARINO	DETROIT DIESEL MARINO 6V53 / 8V53 / 6-71 / 6V71 / 8V71 / 12V71 / 16V71 / 6V92 / 8 V92 / 12V92 / 16V92	AHP33450-36BL



MANGUERAS QUE
SUPERAN A LA
COMPETENCIA EN
CUALQUIER
O C A S I Ó N

Av. Camino a Las Cañadas No. 900
Interior 1 Col. Bosques de San Isidro,
C.P. 45133. Zapopan, Jalisco, México.
Tel: 33 3365 8765

www.alliancehosedemexico.com

Escanea y
descarga la
versión digital:

